



HLA-120

5/2 Day Programmable Outlet Freeze Protection Thermostat

Installation and Operating Instructions

General Information

Thank you for your confidence in our products. To obtain the best results from your investment, please read these instructions and acquaint yourself with your purchase before installing your new thermostat. Then follow the installation procedures, one step at a time. This will save you time and minimize the risk of damaging the thermostat and the system it controls. These instructions may contain information beyond that required for your particular installation. Please save for future reference.

IMPORTANT! Please read all instructions carefully before beginning installation. Save them for future reference.

Your Heat-Line HLA-120 is factory programmed. Set the day and time as per Operating Instructions and enter RUN mode to begin operation. No further programming required.

WARNING: Only use with 120V-15A GFCI model Heat-Line brand self-regulating heating cable systems.

Compatibility

The Heat-Line HLA-120 Programmable Outlet Thermostat is for use with 120Volt, 15 Amp plug-in, 60 Hz GFCI model Heat-Line Self-Regulating Freeze Protection Systems including **CARAPACE, EXT5R, EXT3T, Paladin for Pipe, Heat-Line, Retro-DWS, Retro-FM, Retro-Line, Rizer-Line, and Tandem-Link** systems. This is a temperature control designed to increase energy efficiency of Heat-Line brand products, it is **NOT** to be used as a high limit device.



Features

- Heating Only
- Electronic
- Programmable
- Plugs into normal 120 Volt 15 Amp Electrical Outlet
- 5/2 Day Programming (Weekdays and Weekends can be different)
- Positive On/Off Switch
- Easy to Install
- 4 Periods Per Day
- 120VAC
- 2 G13A size 1.5V Alkaline Button Cell Batteries Included (For Clock Only)
- Temporary and Constant Temperature Override
- Armchair Programming
- Battery Free Nonvolatile Memory For All Programs And Settings
- User Calibration
- On Screen Low Battery Indicator
- F/C Temperature Display
- Soft Touch Buttons
- 2 Minute Short Cycle Protection
- Adjustable Temperature differential
- 1 Year Warranty

Electrical Ratings

- 120V/60 Hz
- Maximum load is 15 Amps at 120 Volts
- Power Consumption 2 W (maximum)
- Plug and Receptacle NEMA 5-15R (normal household 15 Amp receptacle)

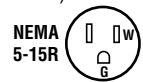

Approvals



WARNING:

Read these rules and instructions carefully. Failure to follow them could result in serious bodily injury and/or property damage.

- Check your local building and electrical codes before installing. You must comply with their rules. The HLA-120 is certified by ETL for Canada and the USA.
- To reduce the risk of electric shock, this product has a grounding type plug that has a third (grounding) pin. This pin will only fit into a grounding type power outlet. If the plug does not fit into the outlet, contact a qualified electrician to install the proper outlet. Do not change the HLA-120 plug arrangement in any way.
- Do not use Outdoors.
- Do not use in a bathroom. Never locate where it may fall into a bathtub or other water container.

CAUTION:

- Do not insert or allow foreign objects to enter any openings as this may cause electric shock, fire, or damage to the thermostat.
- Do not use in areas where gasoline, paint, flammable liquids are used or stored. Designed for ordinary location only.
- Be sure to follow all the Warnings and Cautions provided with the heating cable system instruction manual written by the manufacturer.
- Avoid the use of extension cords as this may increase the risk of electric shock, fire and property damage.
- Use this thermostat only as described in this manual. Any other use not recommended by the manufacturer may increase the risk of fire, electric shock, or injury to persons.
- Never clean this thermostat while it is plugged in. Turn On/Off switch to Off, remove from the wall outlet and then clean by using a rag only.
- Your thermostat is protected against normal static electric discharges. To minimize the risk of damaging the unit in extremely dry weather, touch a grounded metal object before touching your thermostat.
- Be careful not to drop the unit or disturb electronic parts.
- The thermostat contains parts which may wear out through use and are susceptible to failure if over-loaded or used in a manner other than as indicated in this documentation.
- Check unoccupied residences regularly to ensure that all systems are operating properly.
- For thermostats which require batteries to operate, failure or sub-standard performance of batteries may impair or prevent the correct operation of the thermostat. Duracell or Energizer alkaline batteries are suggested.
- **Be sure to change batteries at least once per year.**

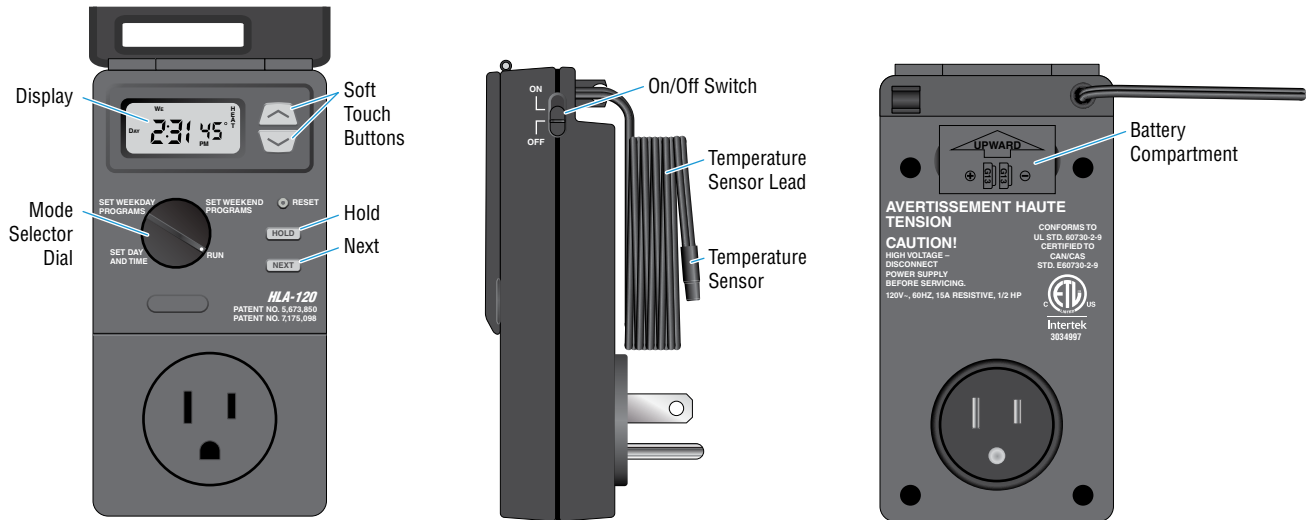

INSTALLATION

TOOLS REQUIRED

- Small standard (blade) screwdriver

LOCATION

- Do not locate in a damp area. This can lead to corrosion that will shorten thermostat life.
- Do not install the unit until all construction work and painting has been completed.
- Do not locate where air circulation is poor, such as in a corner or an alcove; or behind an open door.

PREPARING THE UNIT

1. The HLA-120 comes with (2) G13A size 1.5V Alkaline Button Cell Batteries already installed. These batteries power the clock only during normal operation. They also provide backup power to retain the thermostats programs and settings while it is not plugged into the wall. In order to "activate" them, you must remove the ribbon from between the two batteries prior to using it. Use a small standard (flat) screwdriver to pry open the battery holder and pull out the ribbon.

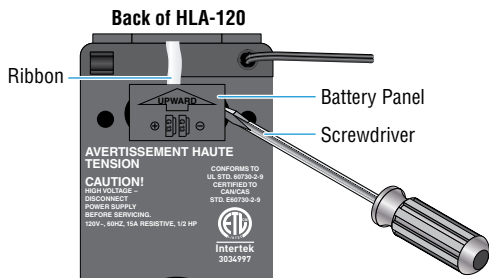

2. When you have the ribbon out, simply push the battery compartment back in while ensuring the directional arrow points upwards.
3. Attached to the HLA-120, there is a 6.7m (22ft.) sensor lead that allows you to locate the sensor or thermistor on the water pipe under the thermal insulation. Gently unwrap the required length and apply to the pipe. The thermostat sensor should be located at the section of the pipe most susceptible to freezing (coldest section).

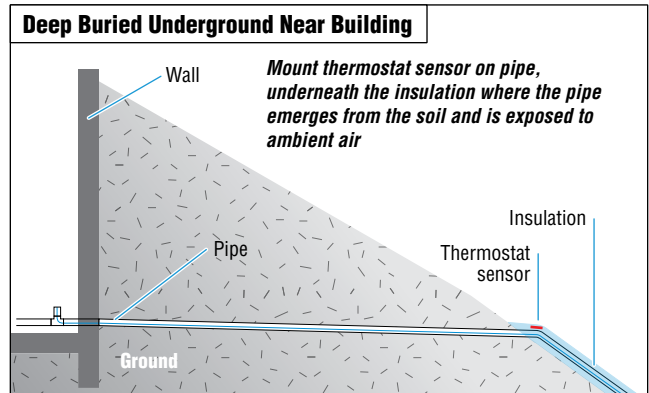
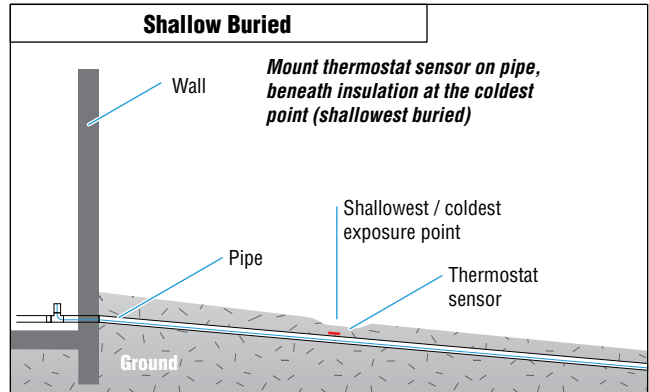
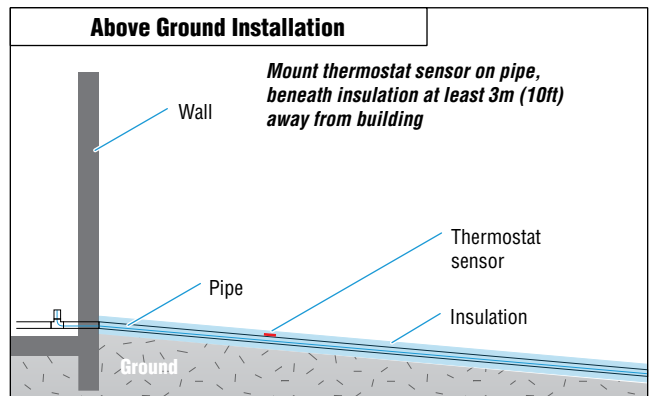

- On the upper right side of the unit, there is an On/Off switch. Place this switch in the OFF position at this time.

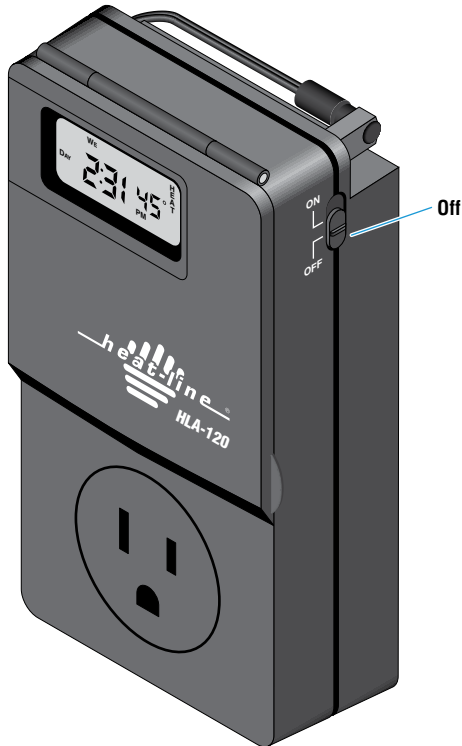

- Plug the HLA-120 thermostat straight into a 120V, 15A electrical outlet on the wall nearest to your Heat-Line power supply. A dedicated 15A electrical circuit, independent of other electrical appliances is recommended.

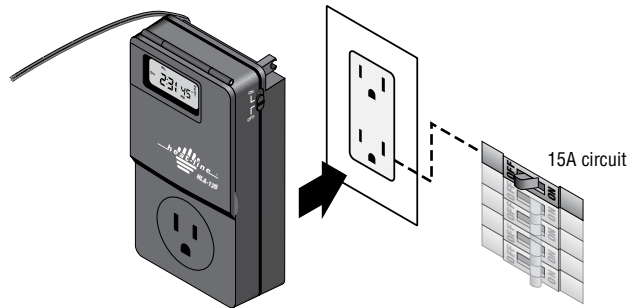

- Plug in the electrical cord from your Heat-Line directly into the front of the HLA-120.

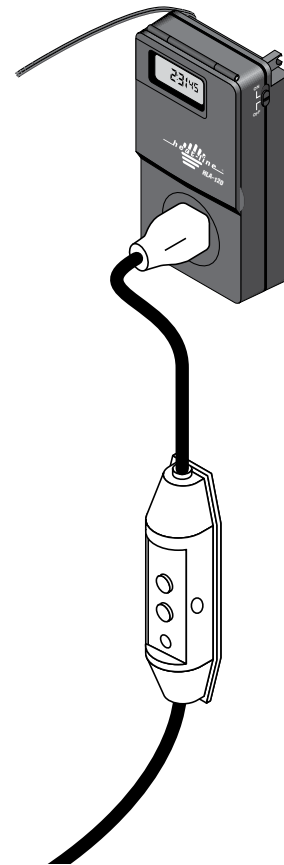

MOUNTING THE HLA-120 AND TESTING YOUR HEAT-LINE SYSTEM

Your GFCI model Heat-Line system is supplied with an integral ground fault circuit interrupter in the cord-set. Prior to plugging the Heat-Line system into the HLA-120 thermostat it is important to confirm the pilot light is ON (lighted) in the cord-set of the Heat-Line system.

- In order to do this, simply plug your Heat-Line system directly into the power supply (not the thermostat) and confirm the pilot light is on. If it is not, press the reset button and the pilot light will illuminate.

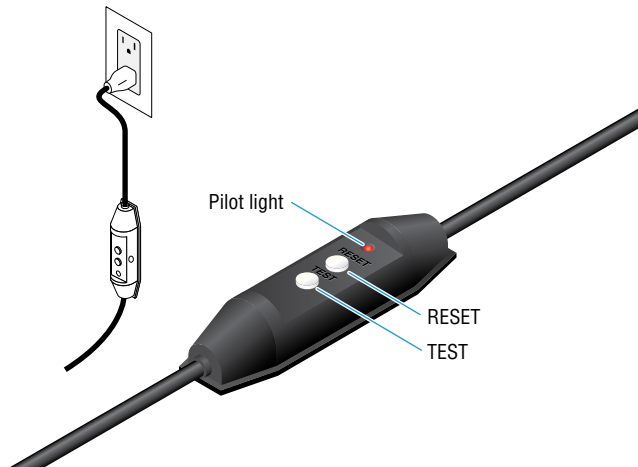

Note: The GFCI shown may not resemble exact model supplied.

WARNING: If the 120 volt electrical receptacle you are plugging the HLA-120 thermostat into has only 2 prongs, STOP, not having a ground wire or ground pin is unsafe. Your Heat-Line system must have a receptacle with 3 prongs on it and correctly wired within the electrical system. Call a certified electrician to be sure your circuitry is correct.

COMPLETING YOUR INSTALLATION

- Configure your thermostat at this time. Refer to the **OPERATING INSTRUCTIONS, PROGRAMMING** and **ADVANCED FEATURES** sections.
- Turn the **ON/OFF** switch on the upper right side to the **ON** position.
- Your installation is now complete.

OPERATING INSTRUCTIONS

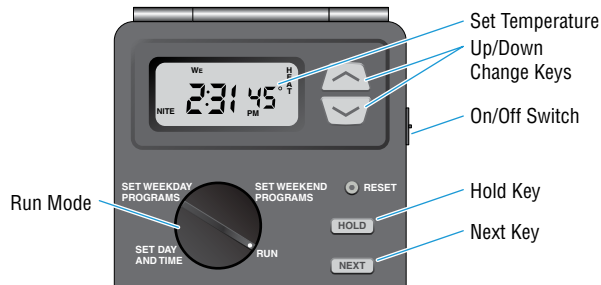

RUN MODE

Your HLA-120 Thermostat is factory pre-set for optimum control but is programmable.

For the thermostat to function, the **Mode Selector Dial** on the face of the thermostat must be turned to the **RUN** position. If you forget to do this, it will not work and the door will not close all the way.

UP/DOWN CHANGE KEYS

- These are the two upper keys, just right of the unit's display. They are used to adjust set temperatures, and make other setting changes.
- Pressing these keys once will adjust a setting one step in the associated direction.
- If there are many choices for a value, usually that setting will advance while holding one of these keys. Some settings though, must be changed one press at a time.

SET DAY AND TIME

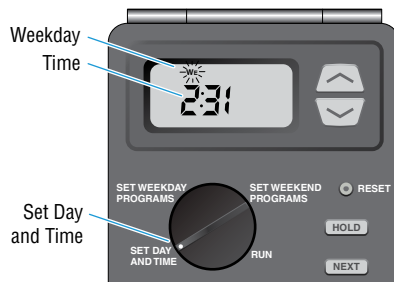

To set the correct time during the initial set-up of the thermostat or after the unit has lost power or following a factory default reset:

1. Open the door on the front of the thermostat by lifting up the bottom of the door.
2. Rotate the **Mode Selector Dial** to **SET DAY AND TIME**. The abbreviation for the day of week will flash.
3. Use the **UP** key to advance to the current day.
4. Press **NEXT** to adjust the time. Time will flash.
5. Use the **UP/DOWN** keys to set the time.
6. Pressing **NEXT** again will toggle from Set Time to Set Day, or vice versa.
7. Return the **Mode Selector Dial** to its **RUN** position.

When a unit has first been powered up with the **Mode Selector Dial** in the **RUN** position, your thermostat will begin to control your freeze protection system according to its default program.

ON/OFF SWITCH

Slide the ON/OFF switch to **OFF** when no freeze protection is desired. Heating will be disabled, even though the set temperature, pipe temperature, and time/day will still be in the display.

DEFAULT PROGRAM

As supplied from the factory, your thermostat will use its Heat-Line HLA-120 program for temperature control. Completing a software reset will default the program to the primary software settings which differ from those provided as default with the thermostat from Heat-Line. To ease reprogramming after a software reset, record your thermostat's programs and settings in the table provided on page 8 of this document before using the reset button.

**For specific information on Heat-Line recommended factory settings please refer to Page 8 of this document.*

HOLD

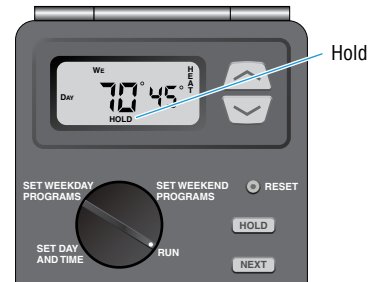

- Hold is the simplest method to maintain fixed set temperatures and allows you to change the current set temperature and maintain it indefinitely until the HOLD is terminated.
- Press **HOLD** once to enter the temperature **HOLD** while in **RUN** or **VERRIDE**. **HOLD** will be displayed on the bottom of the display and the set-point temperature will flash.
- While the Set aTemperature is flashing; press an UP or DOWN key to adjust the set temperature by one degree in the associated direction. Holding the key will automatically advance the setting in the associated direction.
- When you have selected your required Set Temperature allow the Set Temperature to flash five times before it becomes held.
- Pressing the **HOLD** button again will terminate the **HOLD** and return the unit to **RUN** and the programmed set temperature..

TEMPERATURE OVERRIDE

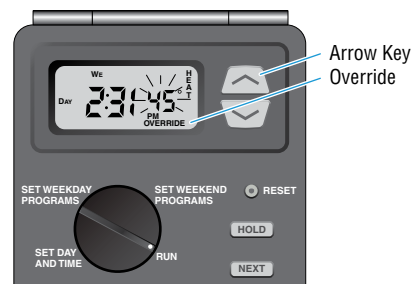

- **VERRIDE** allows you to change the current **SET TEMPERATURE** until the next program period without changing your temperature control programs.
- While in **RUN** press an arrow key once and **VERRIDE** will be displayed on the bottom of the display and the set-point temperature will flash.
- While the Set Temperature is flashing; press an **UP** or **DOWN** key to adjust the set temperature by one degree in the associated direction. Holding the key will automatically advance the setting in the associated direction.
- When you have selected your required Set Temperature allow the Set Temperature to flash five times before it becomes overridden.
- The **VERRIDE** will be canceled at the start of the next program period, and the temperature setting will return to its programmed value.
- An **VERRIDE** may be terminated by rotating the **Mode Selector Dial** and then returning it to **RUN** for the normal programming to once again take over.
- Adjusting the set temperature to its program value will also cancel an **VERRIDE**.

PROGRAMMING

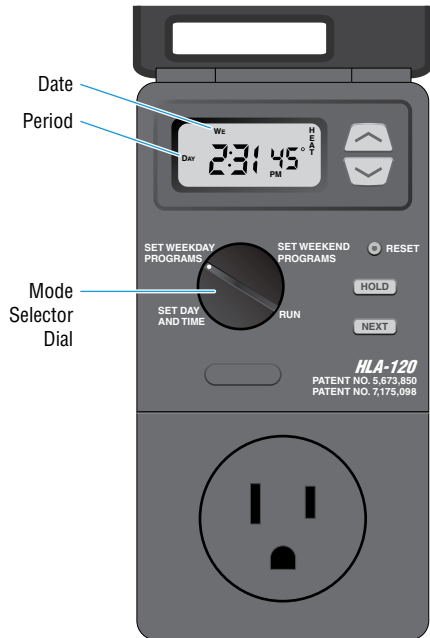

EDITING HEAT PROGRAM (Optional)

The HLA-120 provides one program for heating. This program has separate settings for weekdays and weekends. Every day the program cycles through four independent periods. You can use the default programs or alter them to suit your schedule.

HEAT-LINE FACTORY SUPPLIED TEMPERATURE PROGRAM

As supplied from the factory, the following program will be used for temperature control in **RUN MODE** during the Weekdays and Weekends.

Day	Period	Time	Temperature
Monday thru Friday	Morning	6:00 AM	47°F (8°C)
	Day	8:00 AM	45°F (7°C)
	Eve	6:00 PM	47°F (8°C)
	Night	10:00 PM	45°F (7°C)
Saturday and Sunday	Morning	6:00 AM	47°F (8°C)
	Day	8:00 AM	45°F (7°C)
	Eve	6:00 PM	47°F (8°C)
	Night	10:00 PM	45°F (7°C)

WEEKDAY PROGRAMMING (Optional)



To change the program:

- Rotate the **Mode Selector Dial** to **SET WEEKDAY PROGRAMS**. MORN, Mo, Tu, We, Th, Fr will be displayed, with the Start Time flashing.
 1. Weekday Morn Start Time
 2. Weekday Morn Set Temperature
 3. Weekday Day Start Time
 4. Weekday Day Set Temperature
 5. Weekday Eve Start Time
 6. Weekday Eve Set Temperature
 7. Weekday Night Start Time
 8. Weekday Night Set Temperature
 9. ... and so on until Fri Nite is fully programmed at which point pressing **NEXT** again will begin the list at Mo - Fri Morn Start Time.
- Use the **UP/DOWN** keys to change the start time for this period. Press **UP/DOWN** buttons to change the time in 15-minute increments. Hold **UP/DOWN** button to change the time at a faster rate.
- One period ends at the start time of the next period. The end of one period may not be any closer to the beginning of the next period than one 15-minute increment. Moving a start time too close to the next start time results in the latter time being pushed ahead too. Press **NEXT** to accept the displayed start time and advance to the **SET TEMPERATURE**, it will flash to show that it may be edited.
- The **SET TEMPERATURE** will be displayed on the right side of the display.
- Edit the **SET TEMPERATURE**, then press **NEXT** to accept and advance to the next period.
- When all the periods for the weekdays have been set, the start time for the next weekday Morning period will be displayed to begin editing the settings for that day.
- Complete programming for all weekdays and rotate the dial back to **RUN** to accept all current values and end the programming session.

WEEKEND PROGRAMMING (Optional)

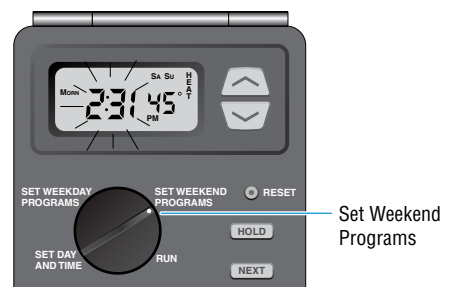

Weekend programming is identical to weekday programming except that you must rotate the dial to **SET WEEKEND PROGRAMS** and the days that you will program are Sa and Su together. This two day program will repeat.

ADVANCED FEATURES

CALIBRATION OFFSET

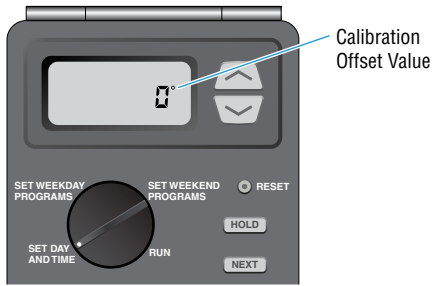

Your thermostat is accurately calibrated at the factory to within 1°F. An offset value up to ± 5°F (± 3°C) may be added to the temperature value that the thermostat measures. This may allow you to match this thermostat to another.

To change this offset from its default value of 0:

1. Open the door on the front of the thermostat.
2. Rotate the dial to **SET DAY/TIME**.
3. Simultaneously press **NEXT** and **HOLD**. The Temperature Offset value will flash.
4. The default value is 0 and in most cases should remain untouched.
5. Use the **UP/DOWN** keys to adjust the offset value.
6. Return the dial to its **RUN** position to accept the new value.

SOFTWARE RESET

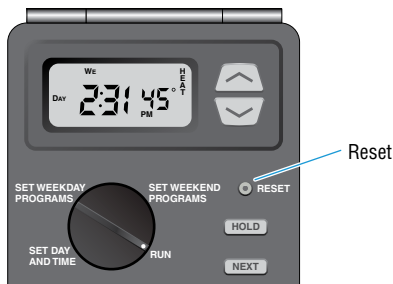

Use this feature to make all settings and programs return to their primary software default values. Press and release **RESET** button using a pen or pencil. It will perform a system check and then returns all settings to their original primary software default values before initiating normal operation. A software reset is only recommended in extreme circumstances as the primary software default settings differ from those provided as default with the thermostat from Heat-Line.

Default Software Reset Settings

Period	Heat Mode
Morning	6:00 AM 70°F (21°C)
Day	8:00 AM 62°F (17°C)
Evening	6:00 PM 70°F (21°C)
Night	10:00 PM 62°F (17°C)

Calibration Offset: 0°F
Swing Adjustment: 1

NOTE: Pressing this button will overwrite your program and install the default values of all temperature programs and setup values into the unit's nonvolatile memory. To ease reprogramming later, record your thermostat's programs and settings in the table provided on page 9 of this document before using this button.

TEMPERATURE VARIATION / SWING

Your thermostat works by turning your heating system on and off whenever the pipe temperature varies a certain number of degrees from the setpoint temperature. This variation is the "swing". Your system should cycle on about 3 to 6 times per hour. A smaller swing number increases the number of cycles, so pipe temperature is more constant. A larger swing number decreases the number of cycles, saving energy in most cases.

Swing value	1	2	3	4	5	6	7	8	9
Degree change	±0.25°	±0.5°	±0.75°	±1.0°	±1.25°	±1.5°	±1.75°	±2.0°	±2.25°

SWING ADJUSTMENT

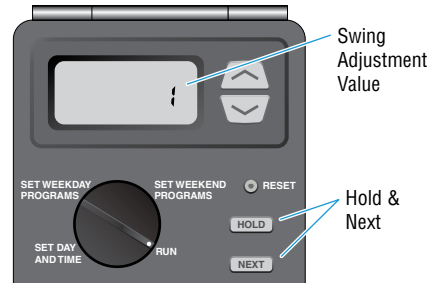

This setting controls when the heating turns on and off.

- The Swing setting sets the temperature variation the system allows above or below the set temperature before turning on the heating. To change this value:
 1. Rotate the **Mode Selector Dial** to **RUN**.
 2. Press **NEXT** and **HOLD** simultaneously. The Temperature section of the display shows a single digit number between 1 and 9.
 3. Select one of the 9 values the **UP/DOWN** buttons.
 4. [1] is the maximum comfort setting (narrow control). [9] is the maximum energy savings setting (wide control).
 5. Press **NEXT**

TEMPERATURE DISPLAY FORMAT

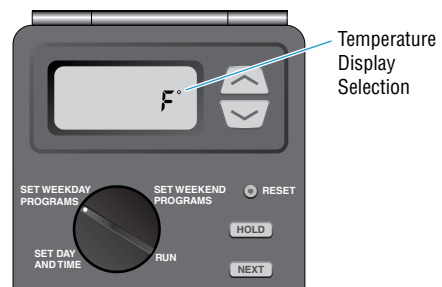

- This feature allows you to display temperature in either degrees C or degrees F.
- To toggle the display mode from Fahrenheit to Celsius or vice versa press and release **NEXT** and **HOLD** simultaneously in **SET WEEKDAY PROGRAMS** position.

BATTERIES/MAINTENANCE

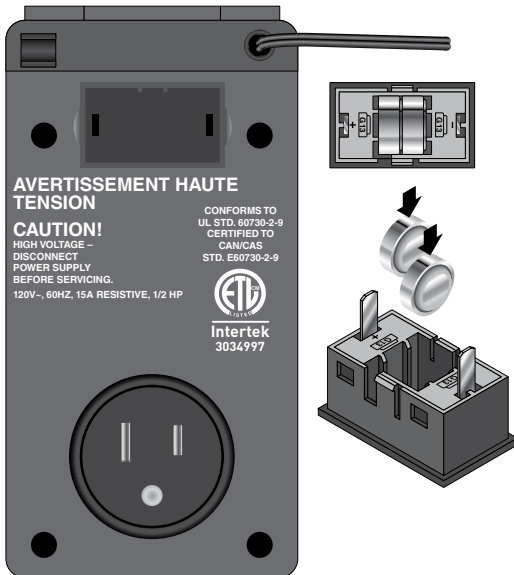

The HLA-120 comes with (2) G13A size 1.5V Alkaline Button Cell Batteries. During normal use, these batteries are used for the clock only. However, they also serve as backup power to retain your programs and

settings if you unplug it from the wall. These (2) batteries will need to be changed **once every year**. The thermostat will alert you when the batteries are low by displaying "**LO BATT**" in the display.

Failure or sub-standard performance of batteries may impair or prevent the correct operation of the thermostat. Duracell or Energizer alkaline batteries are suggested.

BATTERY INSTALLATION

1. Remove fresh batteries from their carton.
2. Slide the thermostat ON/OFF Switch to off and then remove the thermostat from the electrical outlet.
3. Use a small standard screwdriver to remove the battery cartridge from the back of the thermostat. Use the small standard screwdriver to remove the 2 batteries from the holder.
4. Remove the used batteries if present and **replace them within 90 seconds** to avoid having to reset the day and time.
5. Install two new G13A size 1.5V Alkaline Button Cell batteries. Observe the polarity marking (pictures) shown on the battery cartridge.
6. Push the battery compartment back into the HLA-120 while lining up the arrows.
7. Plug the thermostat back into the wall and slide the thermostat ON/OFF Switch to ON for regular operation.

TECHNICAL ASSISTANCE

If you have any problems installing or using this thermostat, please reread the instructions carefully. If you feel you require assistance, please call our offices between 8:00 a.m. and 5:00 p.m. Eastern Standard Time, Monday through Friday. You can also receive technical assistance online at www.heatline.com.

Our toll free number is (800-584-4944) or you can email us directly at info@heatline.com

LIMITED WARRANTY

During the time periods and subject to the conditions hereinafter set forth. Heat-Line will repair or replace to the original user any portion of your HLA-120 product which proves defective in materials or workmanship of Heat-Line. Contact Heat-Line or your installer for warranty service.

At all times Heat-Line shall have and possess the sole right and option to determine whether to repair or replace defective equipment, parts or components. Damage due to natural events or conditions beyond the control of Heat-Line are NOT COVERED BY THIS WARRANTY.

STANDARD WARRANTY PERIOD: 12 months from date of purchase. Proof and date of purchase required.

LABOUR, COSTS, ETC.: Heat-Line shall in NO EVENT be responsible or liable for the cost of field labour or other charges incurred by any customer in removing and/or re-affixing any Heat-Line product, part or component thereof.

THIS WARRANTY WILL NOT APPLY:

- (a) to defects or malfunctions resulting from failure to properly install, operate or maintain the HLA-120 in accordance with printed instructions provided,
- (b) to failures resulting from abuse, accident or negligence;
- (c) to normal maintenance services and

- (d) to parts not used in accordance with applicable local codes, ordinance and good trade practices;
- (e) if the unit is moved from its original installation location or
- (f) if the unit is used for purposes other than for what it was designed and manufactured.

PRODUCT IMPROVEMENTS: Heat-Line reserves the right to change or improve its products or any component thereof without being obligated to provide such a change or improvement for units sold and/or shipped prior to such change or improvement.

WARRANTY EXCLUSIONS: As to any Heat-Line product after the expiration of the time period of the warranty applicable thereto as set forth above. There will be no warranties including any implied warranties of merchantability or fitness for any particular purpose. No warranties or representations at any time made by any representative of Heat-Line, shall vary or expand the provisions hereof.

LIABILITY LIMITATION: In no event shall Heat-Line be able or responsible for consequential, incidental or special damages resulting from or related in any manner to any Heat-Line product or parts thereof. In the absence of suitable proof of the purchase date, the effective date of this warranty will be based upon the date of manufacture plus 90 days.

PROGRAMMING CHART

The chart below is provided for you to write down your existing Weekday and Weekend program times and temperatures in case you have to enter them again at a later date.

Day	Period	Time	Temperature
Monday thru Friday	Morning		
	Day		
	Eve		
	Night		
Saturday and Sunday	Morning		
	Day		
	Eve		
	Night		

HEAT-LINE FACTORY SUPPLIED SETTINGS

In case of a software factory reset please see below Heat-Line HLA-120 factory settings as designed and recommended by Heat-Line.

Day	Period	Time	Temperature
Monday thru Friday	Morning	6:00 AM	47°F (8°C)
	Day	8:00 AM	45°F (7°C)
	Eve	6:00 PM	47°F (8°C)
	Night	10:00 PM	45°F (7°C)
Saturday and Sunday	Morning	6:00 AM	47°F (8°C)
	Day	8:00 AM	45°F (7°C)
	Eve	6:00 PM	47°F (8°C)
	Night	10:00 PM	45°F (7°C)

Calibration Offset: 0°F
Swing Adjustment: 9

Calibration Offset

Your thermostat is accurately calibrated at the factory to within 1°F. An offset value up to ±5°F (±3°C) may be added to the temperature value that the thermostat measures. This may allow you to match this thermostat to another.

Temperature Variation / Swing

Your thermostat works by turning your heating system on and off whenever the pipe temperature varies a certain number of degrees from the set-point temperature. This variation is the "swing". Your system should cycle on about 3 to 6 times per hour. A smaller swing number increases the number of cycles, so pipe temperature is more constant. A larger swing number decreases the number of cycles, saving energy in most cases.

Heat-Line
A division of Christopher MacLean Ltd.
 1095 Green Lake Road
 Algonquin Highlands, ON Canada
 KOM 1J1
 Tel: (705) 754-4545
 (800) 584-4944
 Fax: (705) 754-4567
 info@heatline.com
www.heatline.com

Heat-Line, CARAPACE, EXT5R, EXT3T, Paladin, Retro-DWS, Retro-FM, Retro-Line, Rizer-Line, and TandemLink are registered trademarks of Heat-Line Corporation.

Important: All information, including illustrations, is believed to be reliable. Users, however, should independently evaluate the suitability of each product for their particular application. Heat-Line a Division of Christopher MacLean Ltd. makes no warranties as to the accuracy or completeness of the information, and disclaims any liability regarding its use. Heat-Line's only obligations are those in the Heat-Line Standard Terms and Conditions of Sale for this product, and in no case will Heat-Line be liable for any incidental, indirect, or consequential damages arising from the sale, resale, use, or misuse of the product. Specifications are subject to change without notice. In addition, Heat-Line reserves the right to make changes—without notification to Buyer—to processing or materials that do not affect compliance with any applicable specification.