



Paladin®

Pre-Assembled Heating Cable Set for Roof and Gutter Applications

Installation Instructions



General Information

Paladin pre-assembled professional-grade self-regulating heating cables are designed for residential and commercial roof & gutter de-icing applications. The heating cable sets are rated at 5W/ft at 50°F (10°C) and are available in both GFC and CS Models. Each model is also available in either 120V or 240V power supply options. Refer to page 2 of this document for information on part numbers and models.

Each GFC model comes assembled with a 48 inch (1.2 m) power cord and plug (5-15P 120V or 6-15P 240V) and includes a built in ground-fault protection device (GFCI). Paladin CS models are designed for hard usage direct wire installations with a 72 inch (1.8 m) cold lead and cable gland strain relief for use with a field installed certified enclosure. Ground fault circuit protection is required and is to be installed on-site for all CS Model Paladin systems per the Canadian and National Electrical codes.

Heat-Line offers GFCI protection devices in the form of the MA-10 for indoor ordinary location installations.

1. Paladin heating cable systems are suitable for use on all standard roofing materials including metal, asphalt, composite, shake, rubber and plastic roof substrates (for slate roofs see EDGE-CUTTER®). This includes gutters/ eavestroughs and downspouts made from standard materials such as metal and plastic.
2. Paladin heating cable systems can be used in tandem with snow guards and snow fences as required.
3. When planning circuit lengths refer to page 2 of this document for information on maximum circuit lengths.
4. If the Paladin cable must be taken off and re-installed, carefully follow all installation instructions.
5. Do not install when outdoor temperatures are less than -40°F (-40°C).
6. Do not cut the heating cable. Paladin heating cables are pre-assembled systems and are not designed to be tailored on-site or cut in the field.
7. Leave these instructions with the user for future reference.
8. These systems can be used with timers or roof de-icing snow switches where applicable to improve energy efficiency.

Paladin is a technically advanced product. Handle it with proper care and be sure not to damage the outer sheaths or jackets of the heating cable.

Read the Safety Instructions and Installation Instructions completely before installing this product.

Approvals



Table of Contents

General Information	1
Warnings	1
Kit Contents	2
Ordering Chart	2
Optional Accessories	2
Pre-Installation Information	3
Paladin Roofing Systems Installation	4
Standard Roof Installation	6
Standing Seam Roof Installation	9
EDGE-CUTTER Installation	12
Flat Roof Installation	15
Gutters and Downspouts	17
Heating Cable Finishing Instructions	18
Use of Control Devices	18
Electrical System Connection	19
Warnings	20
Limited Warranty	20
Extended Warranty Application	21

⚠ WARNING:

Important Safety Instructions and Rules for Safe Installation and Operation

- A. Read these rules and instructions carefully. Failure to follow them could result in serious bodily injury and/or property damage.
- B. Check your local building, plumbing and electrical codes before installing. You must comply with their rules.
- C. Before installing this product have the electrical outlet checked by an electrician to make sure it has been installed in accordance with the National Electrical Code and Canadian Electrical Code. Be certain all electrical connections are protected from rain and other water (dry location). The heating cable must be ground fault protected (included in GFC models, required on site for CS models).
- D. Before installing or servicing your Paladin system BE CERTAIN that the power source is disconnected.

- E. Do not use extension cords.
- F. Never tamper with or alter the electrical apparatus associated with your Paladin system.
- G. Check unoccupied residences regularly to ensure that all systems are operating properly.
- H. The cable jacket must not be cut, nicked, or worn down, therefore:
 - Never cut the cable's outer jacket.
 - Do not install the cable where objects might hit it or cut it or where it might be damaged by rubbing against rough surfaces.
 - Before installation, file and remove any sharp edges on the installation surface which might damage the cable. Make sure the cables cross only smooth, non-abrasive surfaces.

- Do not use any wire or clamps to attach the cable to the roof. Use roof clips or downspout hangers.
- If you discover a nick or worn spot on your cable, immediately disconnect the system and replace the cable. Inspect the cable periodically for damage.
- I. Never attempt to splice or repair a damaged cable. Replace it with a new unit. The system is not designed to be repaired and to do so may create a danger of fire or shock.
- J. The Paladin Roof and Gutter de-icing systems and installations covered in this guide are for normal winter conditions. For extreme weather conditions consult Heat-Line 1-800-584-4944 directly.

WHEN PERFORMING WORK OR REPAIRS ON YOUR WATER SYSTEM BE SURE TO UNPLUG YOUR Paladin SYSTEM FROM THE POWER SUPPLY.

Kit Contents

- A Paladin heating cable (GFC Model Shown)
*Optional Cord-Set (CS Model) power connection
- B Cable Guards (x2)
- C Cable ties (quantity depending on heating cable length)

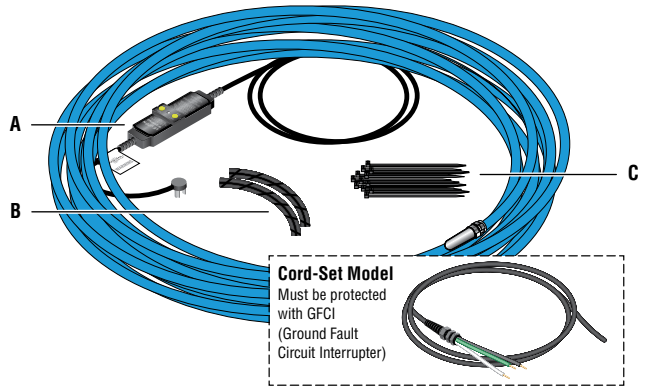

Ordering Chart

Paladin Series | Product Code

Example: **PLDI - 100 - GFC or CS**

Product

- PLDI 120 volt Paladin 5 watt, TPR heater jacket
- PLDI2 240 volt Paladin 5 watt, TPR heater jacket

Cord-Set Type

- GFC Ground fault protected
- CS Cord connected (No GFCI)

Length of Heater

- 10 to 120 feet 120 volt systems
- 10 to 240 feet 240 volt systems

Optional Accessories

TIMER-120P	120V plug-in timer (GFC)
TIMER-240P	240V plug-in timer (GFC)
TIMER-CS	120/240V hard wire timer (CS)
MA-10	120/240V GFCI/ELCI (CS)
PLD-CG	Cable guards/protectors (package of 4, 6 inches each)
PLD-RC	Roof clips (package of 10)
PLD-ECA	Angle EDGE-CUTTER flashing
PLD-ECF	Flat EDGE-CUTTER flashing
EC-MEM	EDGE-CUTTER membrane (metal roofs)

PCN-RDK-1	Downspout hanger kit
GIT-1	Gutter ice sensor (requires PD or GF-PRO controller)
CIT-1	Snow sensor (requires PD or GF-PRO controller)
LCD-8	Configurable snow switch controller
PD-PRO	Snow/ice controller (requires one or both CIT-1 or GIT-1 sensors)
GF-PRO	Snow/ice controller with GFEP (requires one or both CIT-1 or GIT-1 sensors)
WARRANTY	Extended 10 year limited warranty

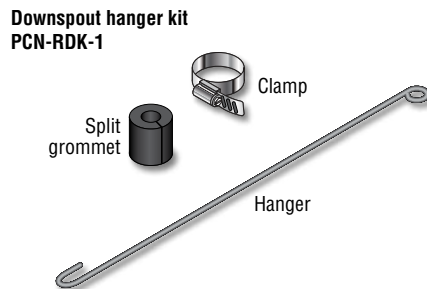
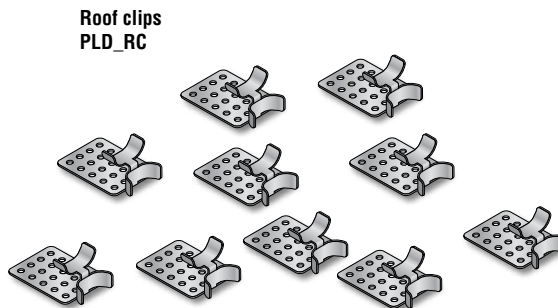

Pre-Installation Information

General Requirements For Roof and Gutter De-icing

- The Paladin heating cable system is designed to provide a melt water path to prevent ice damming, it is not intended to decrease snow loads on roof structures or prevent rooftop snow accumulation.
- Paladin heating cable will not keep snow or ice from falling or sliding off the roof. Snow fences or snow guards should be used to eliminate snow movement. Do not extend heating cable above the installed snow fence or guards.
- Paladin heating cables may be used on:
 - Roofs made from all types of standard roofing materials, including shake, shingle, rubber, tar, wood, metal and plastic.
 - Gutters made from standard materials, including metal and plastic.
 - Downspouts made from standard materials, including metal and plastic.
- The layout and installation of the Paladin heating cable depends primarily on the roof type. Refer to the following sections of this document for information on layout and installation methods.
- The heating cable needs to be in contact with the snow or ice to work properly. Do not install the heating cable underneath any roof covering for roof and gutter deicing (See EDGE-CUTTER).
- If ice dams are not present on the roof, the installation of Paladin on the roof edge may not be required. Installing the Paladin in gutters/ eavestroughs and downspouts may be sufficient to shed water and potential melt.
- When installing Paladin on the roof edge to prevent ice dams, if gutters/ eavestroughs and downspouts are present they must also be heated to provide a continuous melt water pathway for water to run off. In residential or small commercial applications a single run of heating cable in the gutters/ eavestroughs and downspouts is often enough.
- For installations that contain downspouts ensure the Paladin heating cable is long enough to extend down the downspout into a heated area or below the frost line.
- Do not run the heating cable through walls, ceilings, or roof.
- To avoid damage to the Paladin heating cable do not walk on or install heating cable in an area where it may be walked on.
- For Paladin heating cable layouts other than the traditional serpentine use at least one roof clip to secure the heating cable every 5 to 10 ft (1.5 to 3m) of unsupported heating cable or one every change in direction.
- For Paladin roof clip installations it is not recommend to use adhesive or epoxy on slate or tile roofs (for slate or tile roofs see EDGE-CUTTER).
- Do not apply any epoxy and or adhesive directly to the heating cable jacket.
- For applications or installations on large commercial buildings contact Heat-Line 1-800-584-4944 directly for guidance on product application and snow control options.

Electrical Codes

Part 1, Section 62 of the Canadian Electrical Code (CEC) and Article 426 of the National Electrical Code, govern the installation of Paladin heating cables for roof and gutter de-icing and must be followed.

Important: For the Heat-Line warranty to be valid, you must comply with all the requirements outlined in these guidelines.

Bending the Cable

When positioning the heating cable on the roof, do not bend tighter than 1/2" radius.

The heating cable does not bend well on a flat plane. Do not force such a bend as heating cable may be damaged.

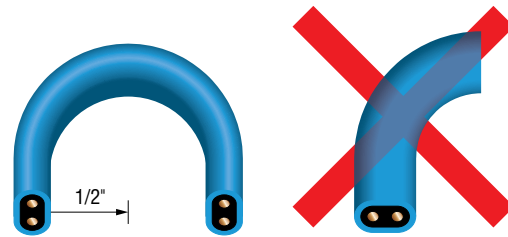

IMPORTANT: Read Installation Instructions completely before determining heating cable length required and beginning installation process.

Paladin Roofing Systems Installation

1A

- Determine the layout of the heating cable desired and the length of cable required.
- Make note of any accessories that may be required. Paladin is supplied with the heating cable only, accessories are additional.
- When determining quantity and/or length of heating cable(s) system(s), consider the following:
 - Total length of leading roof edge
 - Roof eave overhang distance
 - Measurement around any dormers if required
 - Number and length/height of any valleys
 - Number and length of any downspouts
- Number and length of any underground drainage following downspouts
- Locate all power supplies and note whether 120V and/or 240V is available
- If using with EDGE-CUTTER flashings layout the installation locations of the EDGE-CUTTER first
- Be sure to keep the maximum lengths in mind when determining where to start and finish each heating cable system.
 - 120V systems – maximum length of 120 ft. (37 m)
 - 240V systems – maximum length 240 ft. (73 m)
- Use charts below as a further guide.

Table 1. Cable Required for Standard (Serpentine) Roof

Overhang	Tracing width	Tracing heights	Feet of Paladin per foot of roof edge not including gutter
None*	24 in	12 in	2.5 ft
12 in	24 in	24 in	3.1 ft
24 in	24 in	36 in	4.2 ft
36 in	24 in	48 in	5.2 ft

* Gutter required

Table 2. Cable Required for Standing Seam Metal Roof**

Overhang	Tracing heights	Feet of Paladin per foot of roof edge	
		18 inch standing seam spacing (trace every other seam)	24 inch standing seam spacing (trace every other seam)
None*	18 in	2.5 ft	2.0 ft
12 in	24 in	2.8 ft	2.4 ft
24 in	36 in	3.6 ft	2.9 ft
36 in	48 in	4.3 ft	3.6 ft

* For standing seam roofs with gutters, heating cable must be run to the bottom of the gutter. You can determine the amount of extra heating cable required by adding twice the gutter depth per seam traced to the total amount required in Table 2.

** For standing seam roofs without gutters, add 6 inches of heating cable to the total amount required in Table 2 for each seam traced to allow for a 2–3 inch drip loop.

Note: For standing seam spacing greater than 24 inches heat trace every seam.

Table 3. Cable Required for EDGE-CUTTER System

Feet of Paladin per foot of roof edge not including gutter
1 : 1

Additional Notes To Consider:

- For standard roofs, add 1 foot of heating cable for each foot of gutter.
- Add 1 foot of heating cable per foot of downspout. If downspout is in the middle of the run, add 2 feet of heating cable per foot of downspout as the Paladin will need to loop down and back up.
- For valleys, run the heating cable two thirds of the way up and down the valley.
- For roof/wall intersections, run the heating cable two thirds of the way up and down the intersection point.

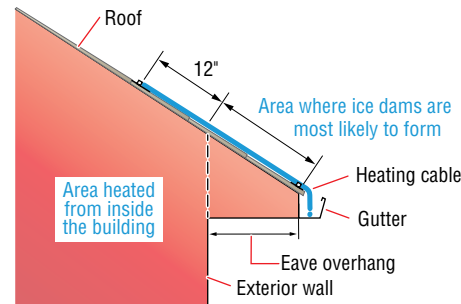
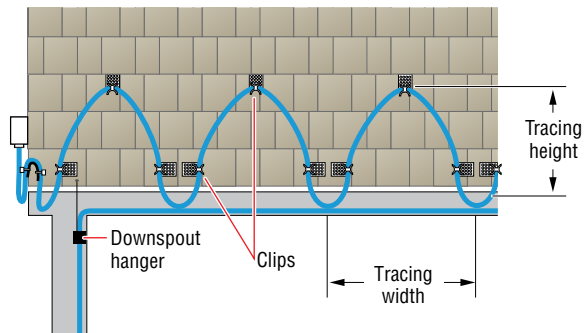

Calculate the heating cable length required.

Total heating cable length:

$$\begin{aligned}
 & \text{Roof edge length (ft)} \times \text{feet of heating cable per foot of roof edge} \\
 & + \text{Total gutter length (ft)} \\
 & + \text{Total downspout length (ft)} (+ 1 \text{ ft}) \\
 & = \text{Total heating cable length (ft)}
 \end{aligned}$$

Example: (standard roof)

- Roof edge: 15 ft
- Roof overhang: 1 ft
- Roof gutter: 15 ft
- Downspout (at end of circuit): 15 ft

Paladin heating cable required:

- Roof edge: 15 ft × 2 (from Table 3)
- Roof gutter: 15 ft
- Downspout: 15 ft + 1 ft
- 61 ft
- Paladin required: 70 ft**

Your values

2

Prepare for installation

- Make sure you have all parts required for your installation. See optional accessories listed on page 2.
- Carefully remove your Paladin system.

- It is recommended that a single circuit (15 amp) be installed by a qualified person for dedicated use of the Paladin system. Do not use extension cords.

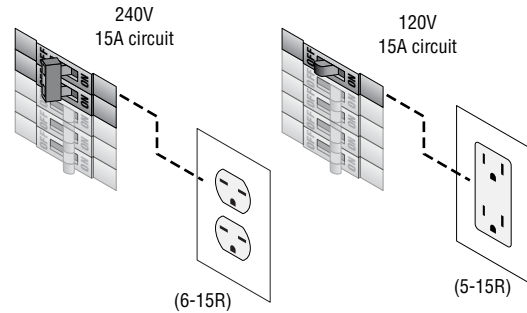
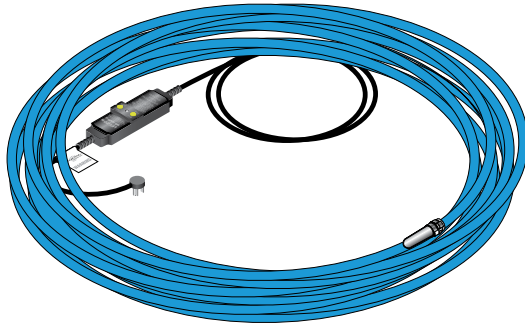

3

- Consider heating cable and accessories placement (roof clips, downspout hangers etc) according to your layout determined in Step 1.
- Clear roof, gutters and downspouts of leaves and other debris.

- Standard roof proceed to Step 4A (page 6)
- Standing Seam metal roof proceed to Step 4B (page 9)
- **EDGE-CUTTER** system proceed to Step 4C (page 12)
- Flat roof proceed to Step 4D (page 15)

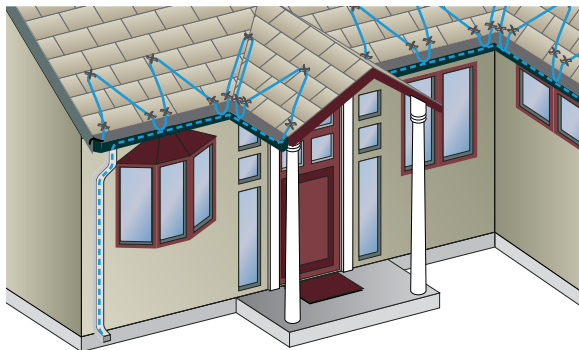

Standard Roof (Serpentine)
Proceed to Step 4A – page 6

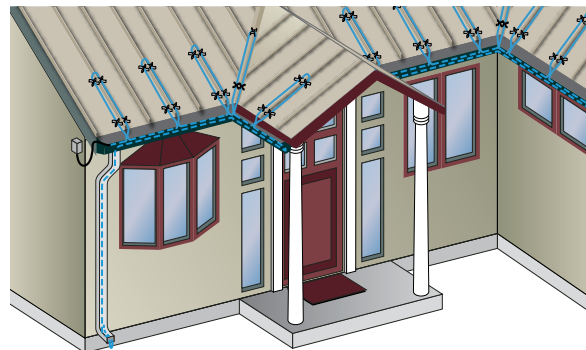

Standing Seam Roof
Proceed to Step 4B – page 9

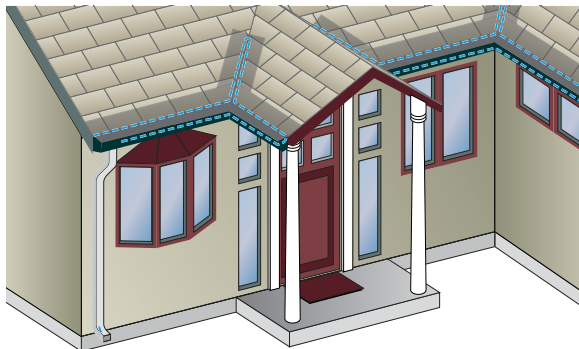

EDGE-CUTTER System
Proceed to Step 4C – page 12

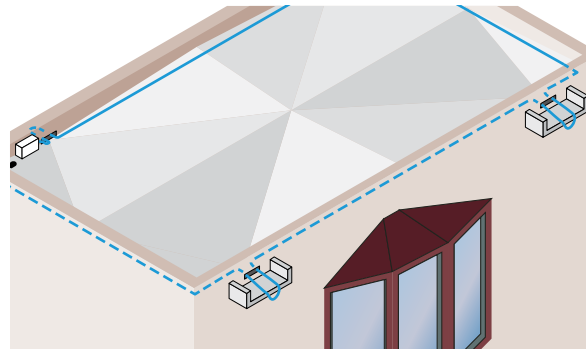

Flat Roof
Proceed to Step 4D – page 15

Standard Roof Installation (continued from page 5)

4A Standard Roof Installation

- Position and attach roof clips on the roof so they are ready to accommodate heating cable.
- Install roof clips in a manner that will allow the heating cable to serpentine on the overhang area of the roof. This is the part that extends past the building wall.
- Roof clip layout is based on tracing pattern required.

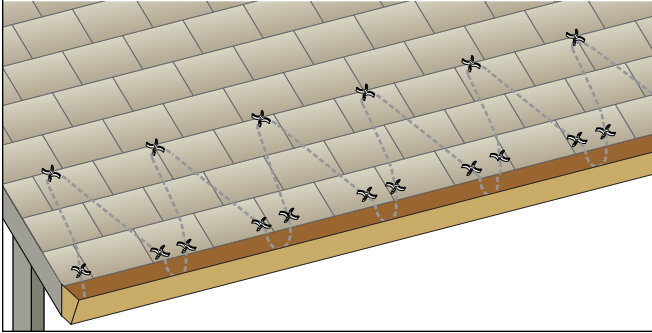

5A Standard Roof Installation

- Lift up shingle to apply roof clip.
- Apply adhesive, appropriate for your roof, to back side of clip where nail or screw will be used.
- Position the clip as needed.
- Attach clip to roof using nails or screws.

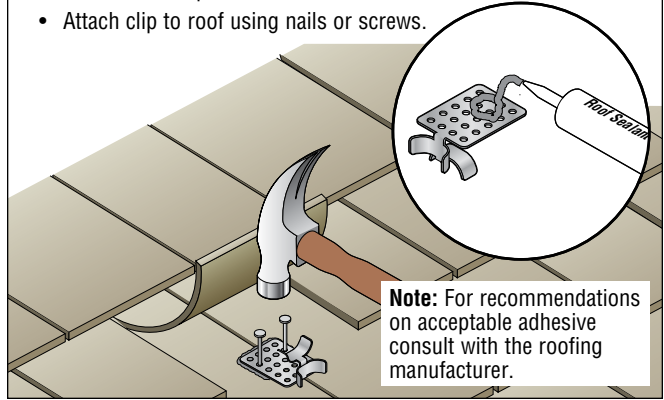

6A Standard Roof Installation

- Spread sealant on top of nail or screw heads and then cover attachment area of clip with roofing material such as shingle.

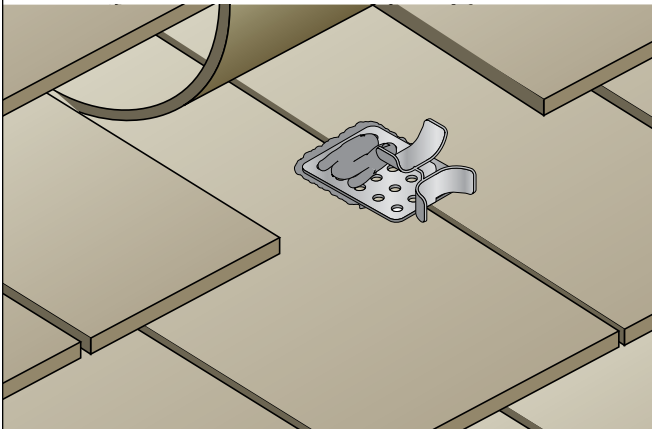

7A Standard Roof Installation

- Install heating cable by gently laying it in the roof clip. Do not pull the heating cable over sharp edges or use excessive pulling force during install.
- Use pliers to close clamps, but do not crush the heating cable.

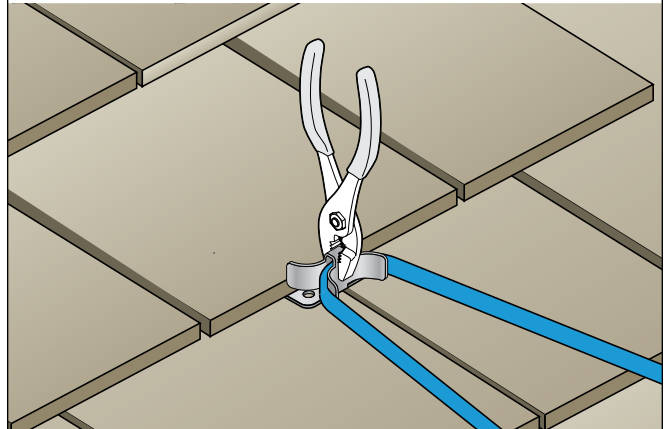

8A Standard Roof Installation

Roofs with gutters:

- When laying the heating cable in the clips, extend the bottom of each heating cable loop over the roof edge (approximately 6 inches) and, using a UV-resistant cable tie, connect the bottom of each loop to the cable running in the gutter to ensure a drainage channel off the roof and into the gutter and downspout.
- For residential and small commercial applications a single run of heating cable is often enough. The cable running in the gutter should remain against the bottom of the gutter. No attachment in the gutters is normally required but roof clips may be used every 2 feet (0.60 m) in the gutter to secure heating cable if needed.

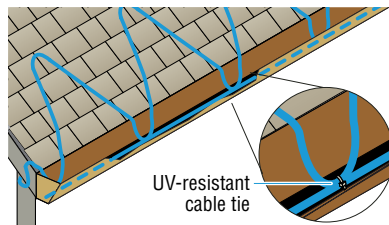

9A Standard Roof Installation

Roof without gutters:

- Route the heating cable to extend the top of each loop beyond where the wall joins the roof and extend past the roof edge slightly. The heating cable running beyond the roof edge creates a drip loop for water to drip free from the roof.

Note: The drip loops at the edge must hang below the lip of the roof.

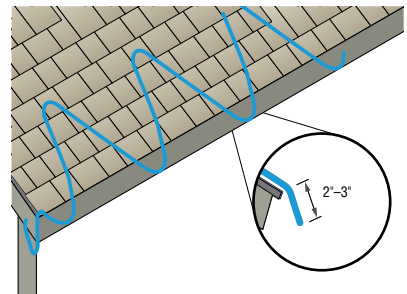

10A Standard Roof Installation

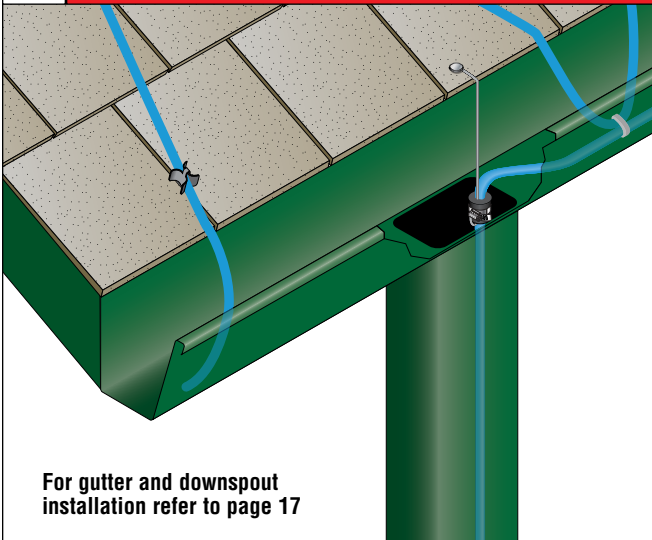

For gutter and downspout installation refer to page 17

11A Standard Roof Installation

Roof with Valley

- Apply the Paladin heating cable at least two-thirds of the way up each valley with a double run, loop the heating cable up and down once.
- The heating cable should extend down into the gutter/ eaves-trough if installed, if not installed the heating cable should extend over the edge of the roof to create a drip loop.
- For attachment of the heating cable in valleys use at least one Paladin roof clip every 5 to 10 feet (1.5 to 3 m) of unsupported heating cable and one at every direction change.

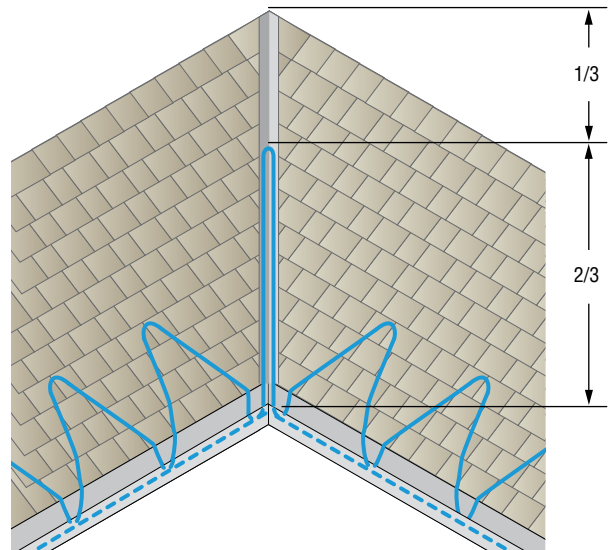

12A Standard Roof Installation

Roof with Roof/Wall Intersection

- Apply the Paladin heating cable at least two-thirds of the way up the slope next to the wall using a double trace up and down similar to a valley.
- The heating cable run closest to the wall should be approximately 2 to 3 inches (50 to 75 mm) away from the wall.
- The return run or second loop of heating cable should be spaced approximately 4 to 6 inches (100 to 150 mm) away from the first.
- For attachment of the Paladin use at least one Paladin roof clip every 5 to 10 feet (1.5 to 3 m) of unsupported heating cable, and one at every direction change.

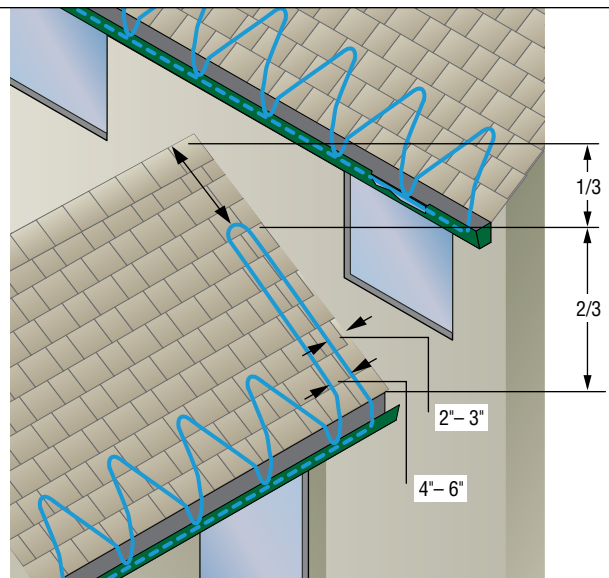

13A Standard Roof Installation

For heating cable finishing instructions refer to page 18

- Finished example of heating cable attached to roof in the Standard Roof (serpentine) installation method.
- Perform an annual inspection each year for the following:
 - Check visually to ensure no physical damage has occurred to the heating cable.
 - Check and test the ground-fault protection device for proper operation. For GFC model Paladin systems refer to the electrical system check section of this guide.
 - Make sure that gutters/eavestroughs and downspouts are free from leaves and any other debris.
 - If a control device is installed make sure it operates correctly before each winter season.

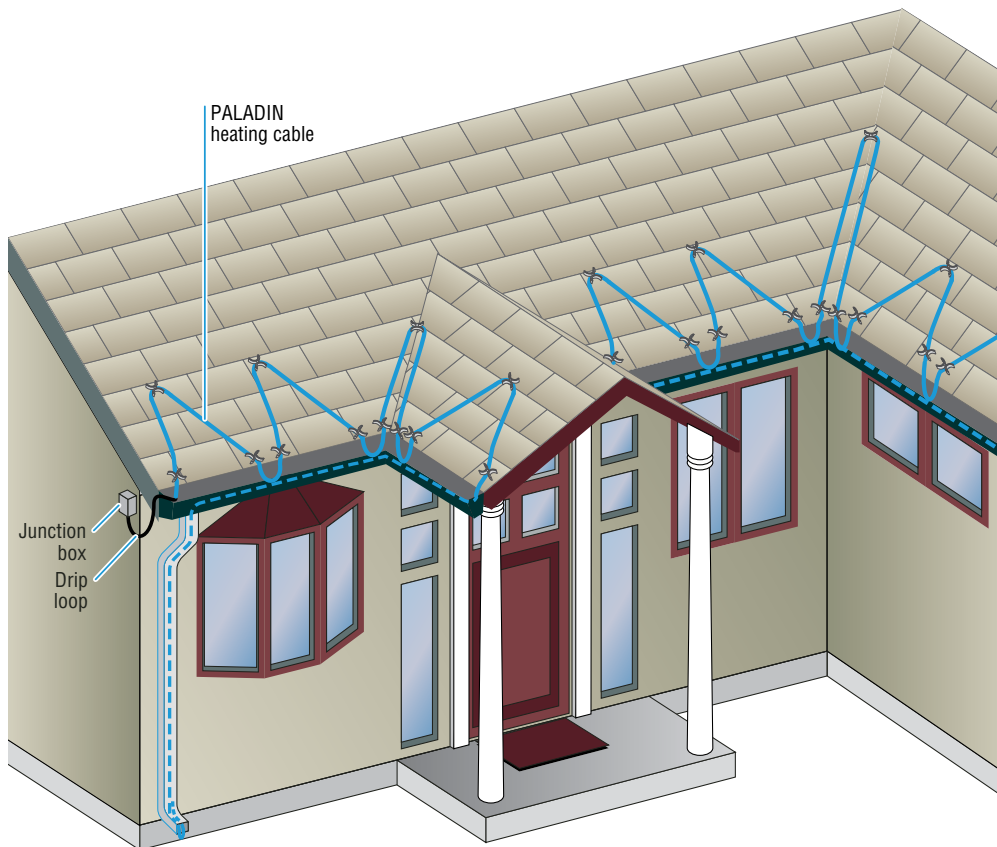

Standing Seam Roof Installation (continued from page 5)

4B Standing Seam Roof Installation

- Position and attach roof clips on the roof so they are ready to allow the heating cable to run up one side of the seam and down the other.
- Install the roof clips in a manner that the heating cable will run up the seam at least 12 inches beyond the non-heated overhang section of the roof, and then so it will run back down and overhang the leading edge of the roof.
- Heating cable is required every other seam on standing seam roofs with seam spaced equal to or less than 24 inches. For seams spaced greater than 24 inches run heating cable up and down each seam.

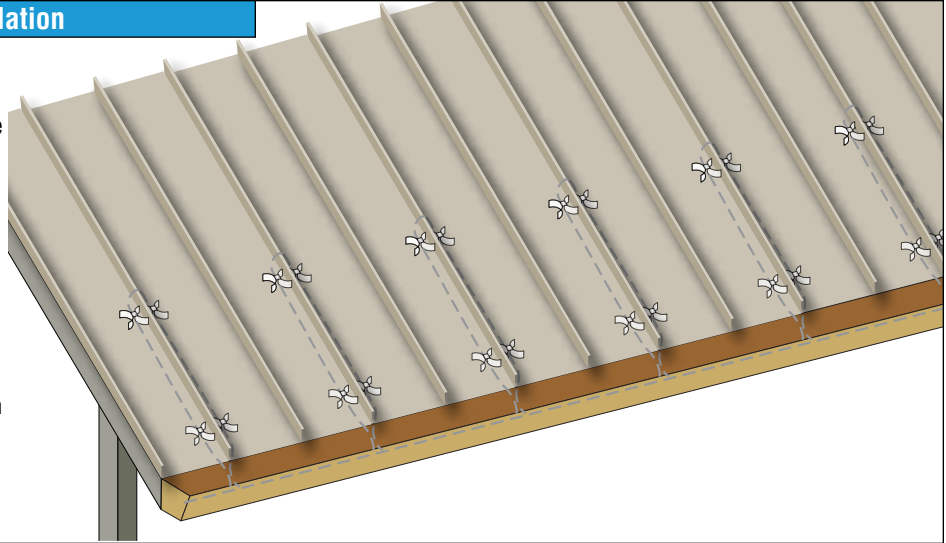

5B Standing Seam Roof Installation

- Prepare roof surface per epoxy manufacturer's specifications
- Apply a liberal amount of epoxy to back side of clip

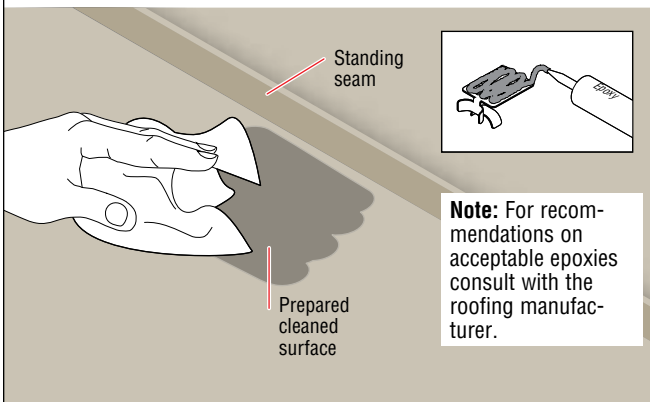

6B Standing Seam Roof Installation

- Place clip on prepared surface. Press down to ensure epoxy flows through holes.
- Do not trim back epoxy beads as they help hold the clip down.
- Allow epoxy to cure per manufacturer's specifications.

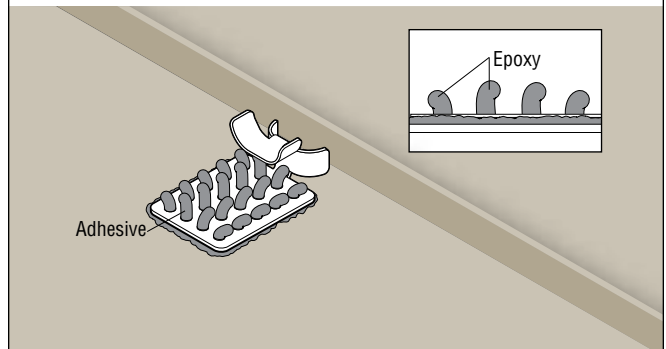

7B Standing Seam Roof Installation

- Install heating cable by gently laying it in the roof clip. Do not pull the heating cable over sharp edges or use excessive pulling force during install.
- Use pliers to close clamps, but do not crush the heating cable.
- Repeat on each standing seam.

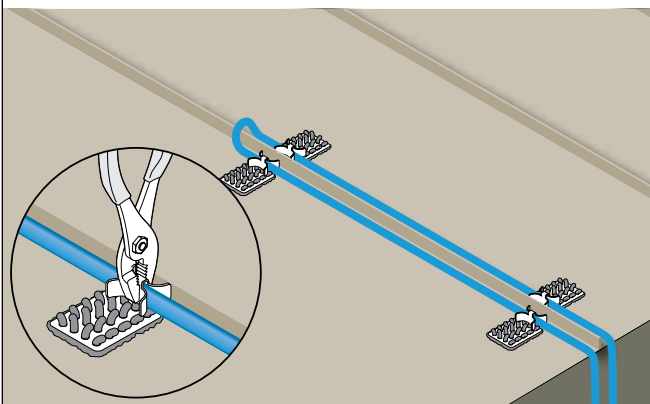

8B Standing Seam Roof Installation

Roofs with gutters:

- When laying the heating cable in the clips, extend the bottom of each heating cable loop over the roof edge (approximately 6 inches) and, using a UV-resistant cable tie, connect the bottom of each loop to each other to ensure a drainage channel off the roof and into the gutter and downspout.
- For residential and small commercial applications a single run of heating cable is often enough. The cable running in the gutter should remain against the bottom of the gutter. No attachment in the gutters is normally required but roof clips may be used every 2 feet (0.60 m) in the gutter to secure heating cable if needed.

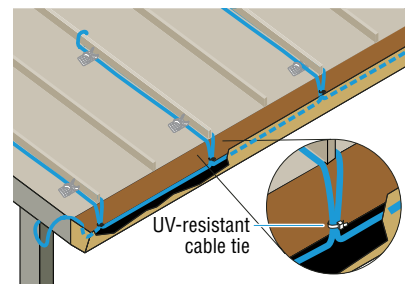

9B Standing Seam Roof Installation

Roof without gutters:

- When laying the heating cable in the clips, route the heating cable to extend the top of each loop beyond where the wall joins the roof and extend past the roof edge slightly. The heating cable running beyond the roof edge creates a drip loop for water to drip free from the roof.

Note: The drip loops at the edge must hang below the lip of the roof.

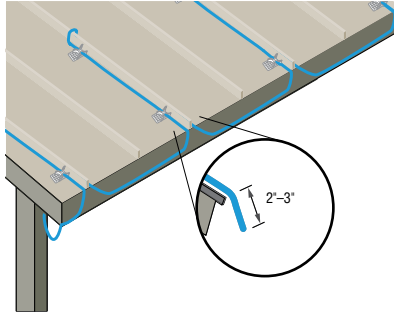

10B Standing Seam Roof Installation

For gutter and downspout installation refer to page 17

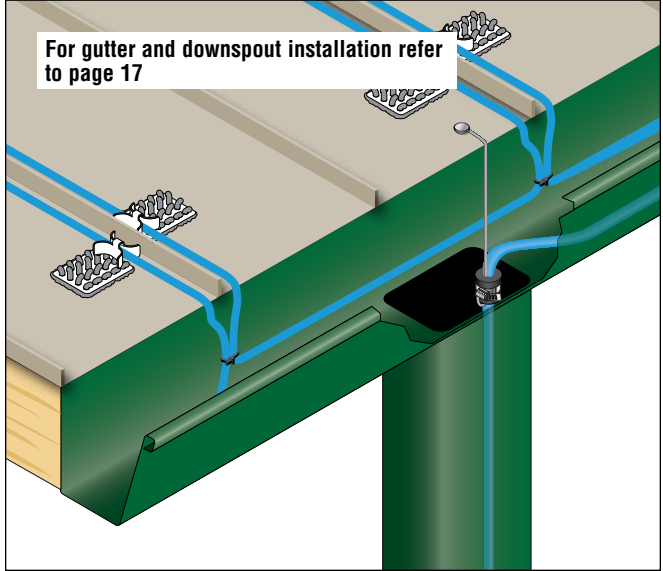

11B Standing Seam Roof Installation

Roof with Valley

- Apply the Paladin heating cable at least two-thirds of the way up each valley with a double run, loop the heating cable up and down once.
- The heating cable should extend down into the gutter/eaves-trough if installed, if not installed the heating cable should extend over the edge of the roof to create a drip loop.
- For attachment of the heating cable in valleys use at least one Paladin roof clip every 5 to 10 feet (1.5 to 3 m) of unsupported heating cable and one at every direction change.

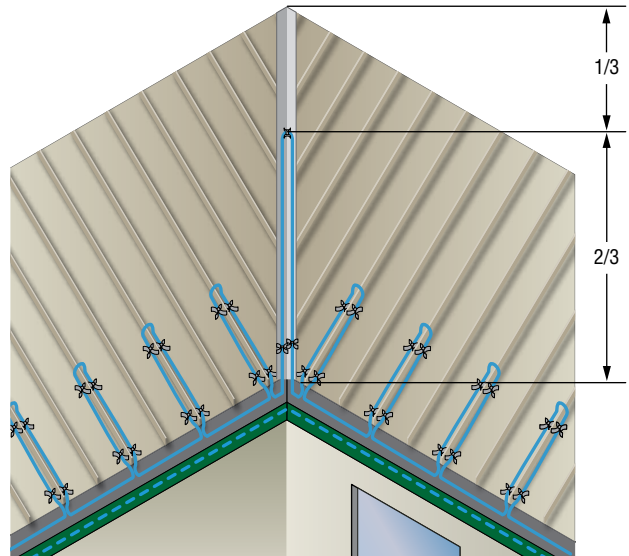

12B Standing Seam Roof Installation

Roof with Roof/Wall Intersection

- Apply the Paladin heating cable at least two-thirds of the way up the slope next to the wall using a double trace up and down similar to a valley.
- The heating cable run closest to the wall should be approximately 2 to 3 inches (50 to 75 mm) away from the wall.
- The return run or second loop of heating cable should be spaced approximately 4 to 6 inches (100 to 150 mm) away from the first.
- For attachment of the Paladin use at least one Paladin roof clip every 5 to 10 feet (1.5 to 3 m) of unsupported heating cable, and one at every direction change.

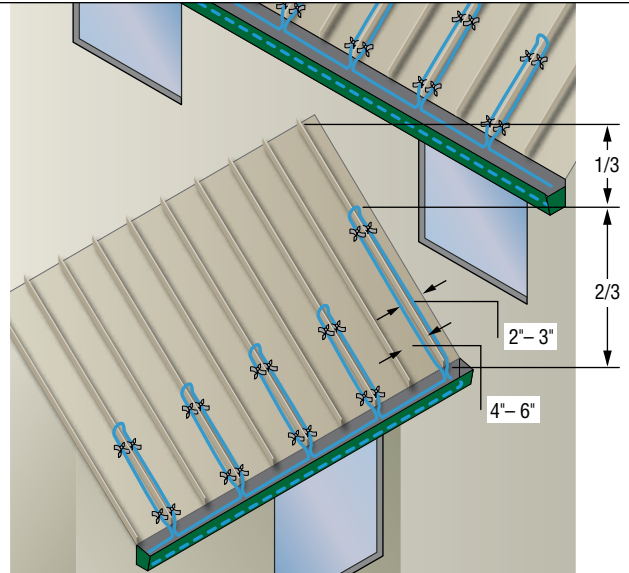

13B Standing Seam Roof Installation

For heating cable finishing instructions refer to page 18

- Finished example of heating cable attached to roof in the Standing Seam Metal Roof installation method.
- Perform an annual inspection each year for the following:
 - Check visually to ensure no physical damage has occurred to the heating cable.
 - Check and test the ground-fault protection device for proper operation. For GFC model Paladin system refer to the electrical system check section of this guide.
 - Make sure that gutters/eavestroughs and downspouts are free of leaves and any other debris.
 - If a control device is installed make sure it operates correctly before each winter season.

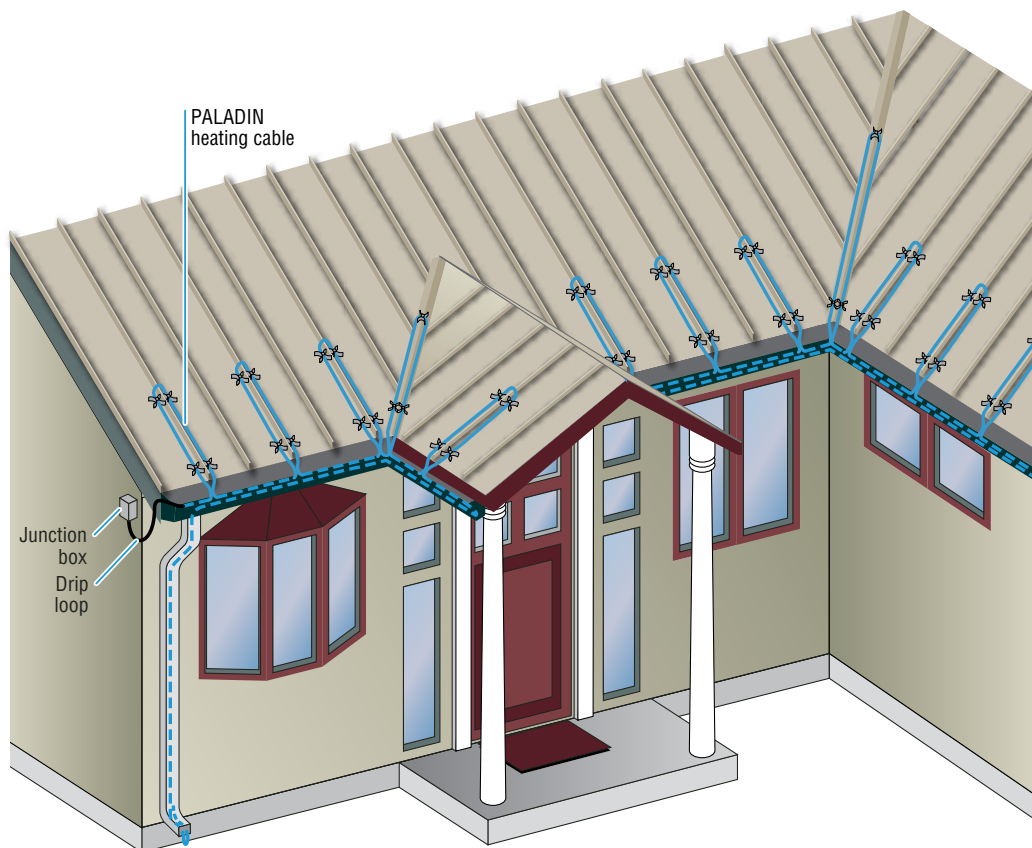

EDGE-CUTTER Installation (continued from page 5)

4C EDGE-CUTTER Installation

- Determine the layout desired and clear roof of leaves and other debris.
- Carefully peel back roofing material, exposing the roof substrate.
- Proceed to install the EDGE-CUTTER flashing only, DO NOT install channel caps until later in the installation. Once channel caps are installed they cannot be removed.

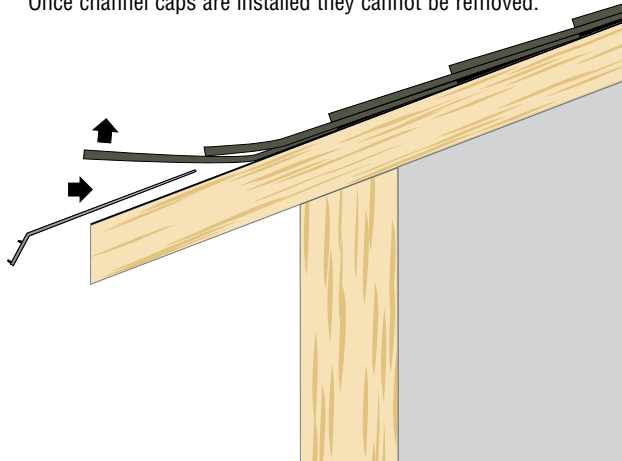

IMPORTANT: EDGE-CUTTER flashings can be cut to suit your specific roof installation situation. After cutting, EDGE-CUTTER flashings and caps must be deburred so no sharp edges remain that could damage the heating cable.

5C EDGE-CUTTER Installation

- Install the EDGE-CUTTER flashing to the roof substrate by using screws, flexible adhesives or both.
- Mounting holes may be installed anywhere in the mounting hole area in the illustration below. Note, a minimum of 1/2" from the bend in the aluminum flashing may not be compromised for mounting purposes.

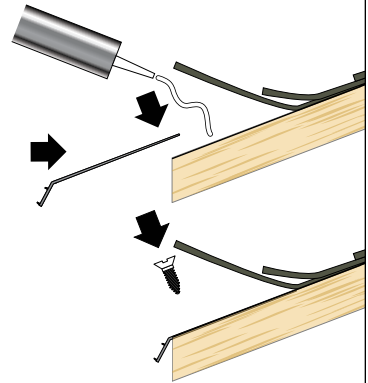

IMPORTANT: Allow 1/4" spacing between flashings to allow for Expansion and contraction of the aluminum.

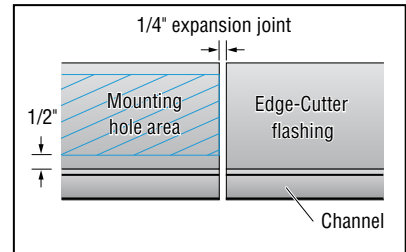

6C EDGE-CUTTER Installation

- Once all EDGE-CUTTER flashings are installed, sweep channel area clean and lay the heating cable in the channel.

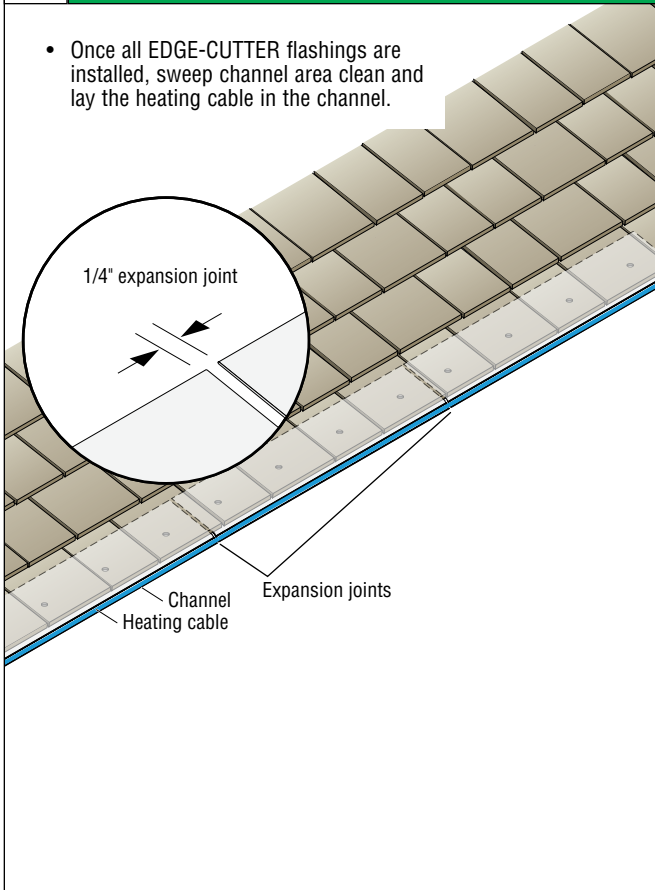

7C EDGE-CUTTER Installation

Installing the Channel Cap Assembly

IMPORTANT: Once channel caps are installed they cannot be removed. Read instructions thoroughly.

- Make sure there is no debris in the barbed areas on the EDGE-CUTTER flashing or channel cap.
- Use a brush or toothbrush to remove any debris. (Even the smallest stone or grain of sand must be removed as it is a very fine barb.)
- Lay the heating cable in the flashing channel.
- Position the channel cap by fitting the top barb first, then snap the channel cap down onto the bottom barb.

Tip: Offset pump pliers work nicely to complete the channel cap installation. You can protect the channel cap from damage by taping the teeth on the pump plier.

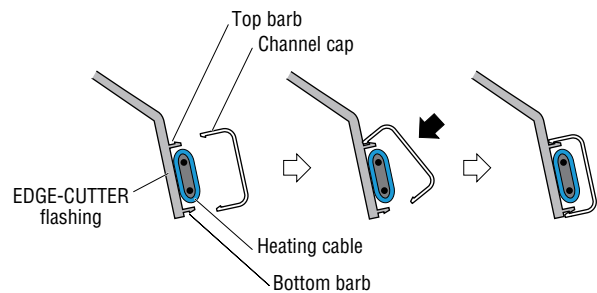

8C EDGE-CUTTER Installation

For gutter and downspout installation refer to page 17

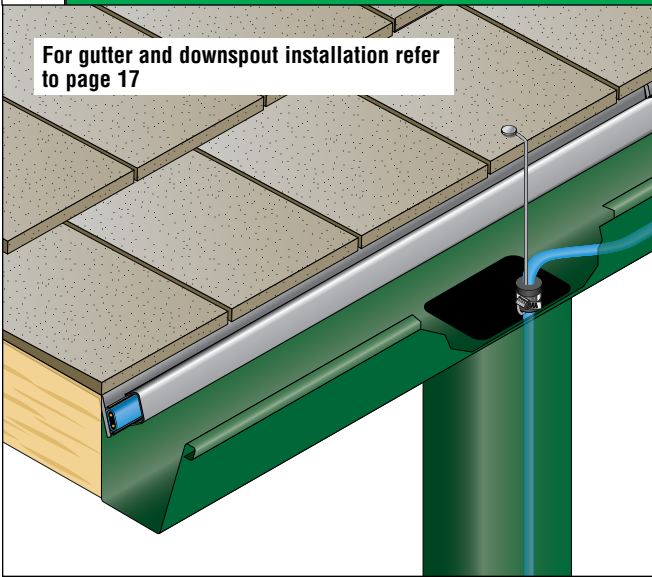
**9C EDGE-CUTTER Installation****Roof with Valley**

- Apply the Paladin and EDGE-CUTTER heating cable at least two-thirds of the way up each valley with a double run, loop the heating cable up and down once.
- For attachment of the heating cable in valleys use the flat EDGE-CUTTER model in a double formation on either side of the valley or use a single run of flat EDGE-CUTTER and then roof clips.
- For attachment of the heating cable in valleys use at least one Paladin roof clip every 5-10 feet (1.5-3 m) of unsupported heating cable and one at every direction change.

Method 1:

Use flashing with the channel on both edges of the valley. Run heating cable up one side and loop it at the top, then down the other side.

Method 2:

Use a single run of flashing with the channel lined up in the middle of the valley. Run the heating cable up the channel of the flashing and then run it back down inside the valley with roof clips to continue in other EDGE-CUTTER flashings.

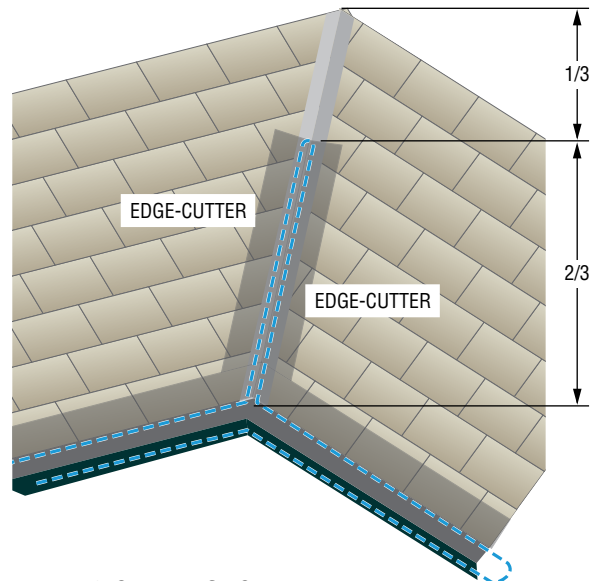
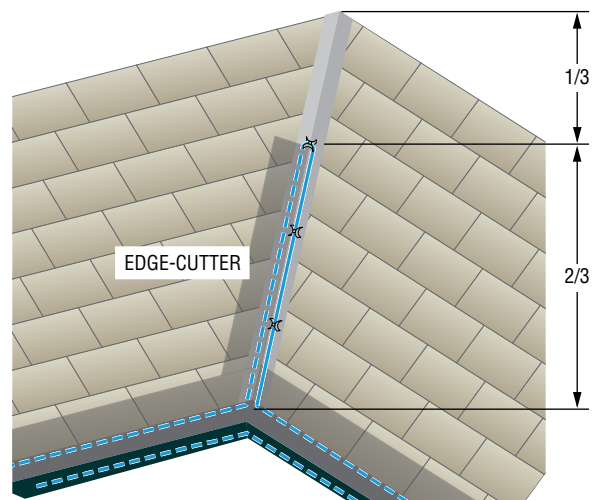
Method 1: Dual EDGE-CUTTER flashings**Method 2: Single EDGE-CUTTER flashing**

11C EDGE-CUTTER Installation

For heating cable finishing instructions refer to page 18

- Finished example of heating cable attached to roof using EDGE-CUTTER installation method.
- Perform an annual inspection each year of the following:
 - Check visually to ensure no physical damage has occurred to the heating cable.
 - Check and test the ground-fault protection device for proper operation. For GFC model Paladin system refer to the electrical system check section of this guide.
 - Make sure that gutters/eavestroughs and downspouts are free of leaves and any other debris.
 - If a control device is installed make sure its operates correctly before each winter season.

* For more information on EDGE-CUTTER flashings refer to their specific installation guide.

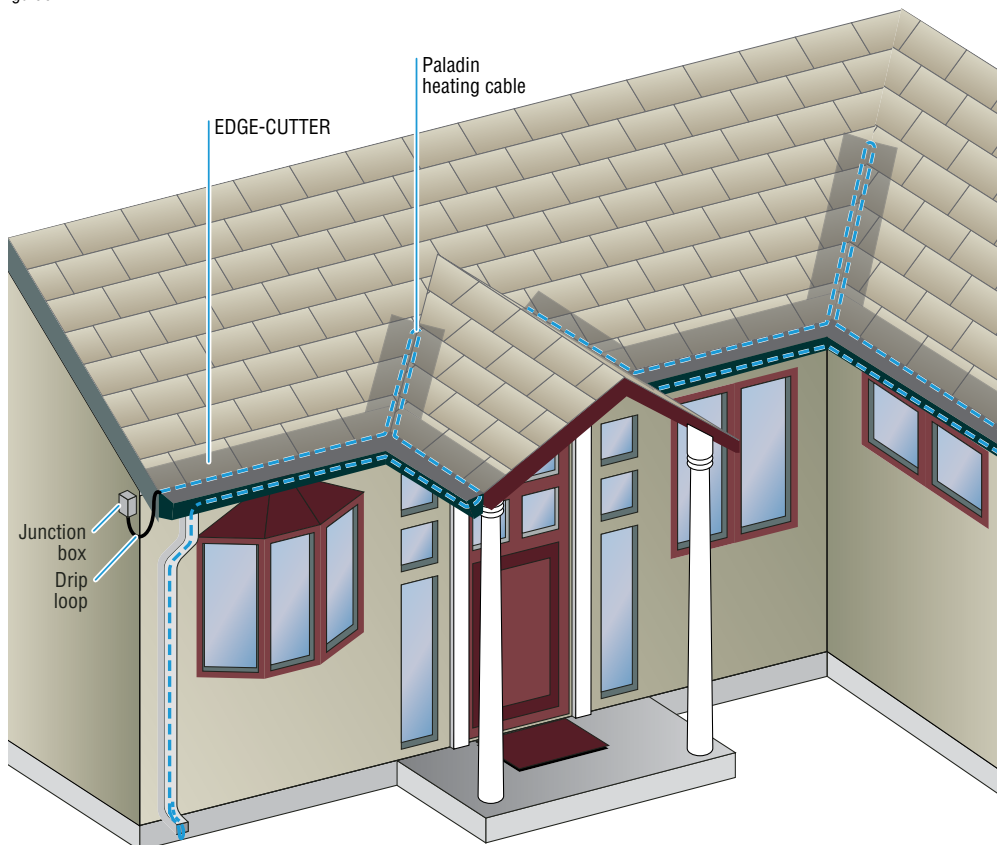

Flat Roof Installation (continued from page 5)

4D Flat Roof Installation

Flat roofs often build up with ice and snow blocking drains. Heating cable may be used to allow a continuous melt water path to the drains. Flat roofs are typically pitched toward drains, plan your heating cable layout as per your application.

- Place heating cable around perimeter.
- Trace valleys from perimeter to drain.
- Extend heating cable into internal downspouts at least 12 inches into heated space.

- External downspouts and scuppers must be treated carefully. A path must be provided for the valley/perimeter heating cable to the point of discharge.
- To avoid damage, do not walk on the heating cable.

Note: Additional heating cable may be needed for downspouts and drains.

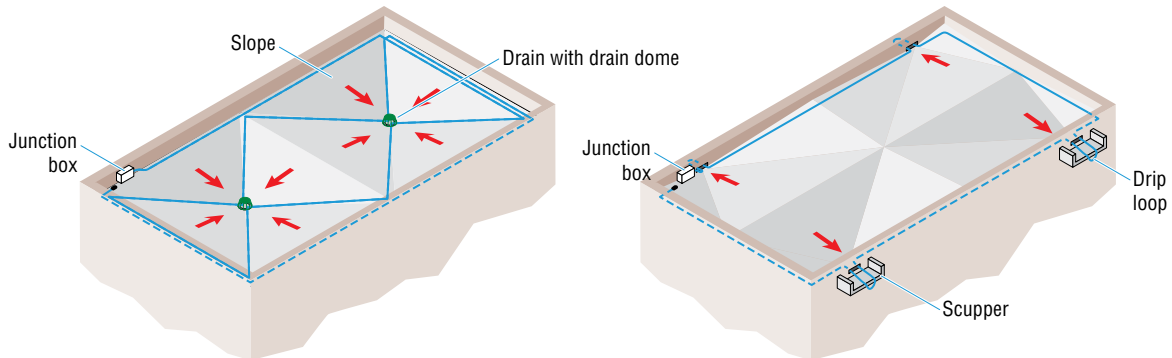

Heating cable should be positioned around the perimeter and in the valleys of a flat roof. The heating cable must extend into the drain or scupper to allow the melt water to exit the roof.

5D Flat Roof Installation

- Position and attach roof clips on the roof so they are ready to accommodate heating cable.
- For attachment of the heating cable use at least one Paladin roof clip every 5-10 feet (1.5-3 m) of unsupported heating cable and one at every direction change.

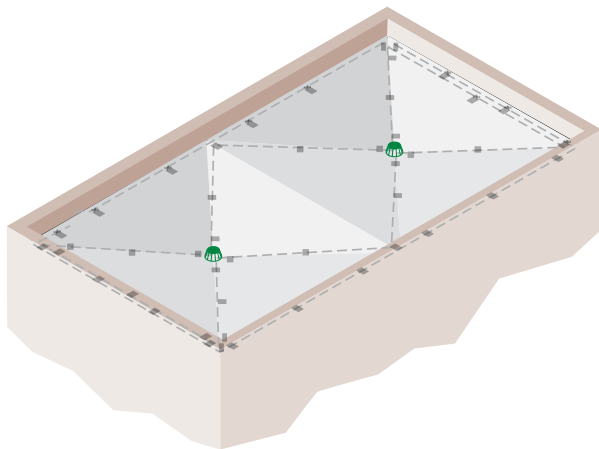

6D Flat Roof Installation

- Prepare roof surface per adhesive manufacturer's specifications.
- Apply a liberal amount of adhesive to back side of clip.

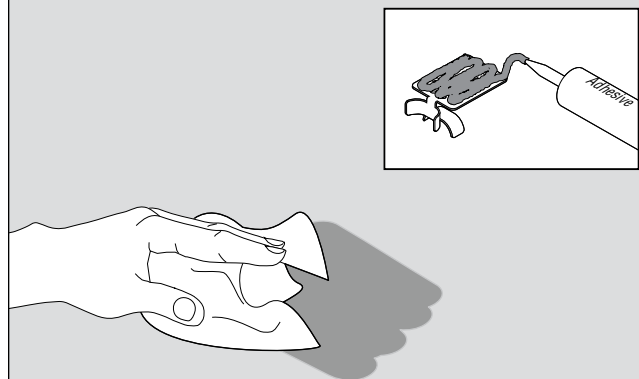

Note: For recommendations on acceptable adhesives consult with the roofing manufacturer.

7D Flat Roof Installation

- Place clip on prepared surface. Press down to ensure adhesive flows through holes.
- Do not trim back adhesive beads because they help hold the clip down.
- Allow adhesive to cure per manufacturer's specifications.

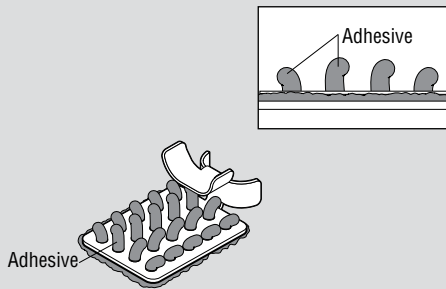

8D Flat Roof Installation

- Install heating cable by gently laying it in the roof clip. Do not pull the heating cable over sharp edges or use excessive pulling force during install.
- Use pliers to close clamps, but do not crush the heating cable.

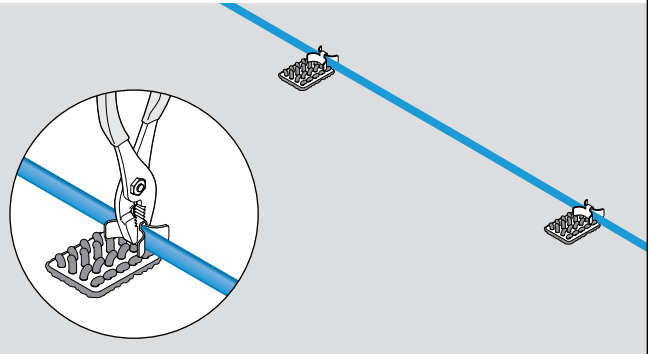

9D Flat Roof Installation

Ice dams and drains

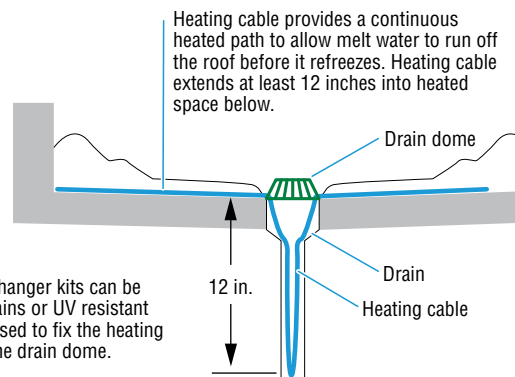
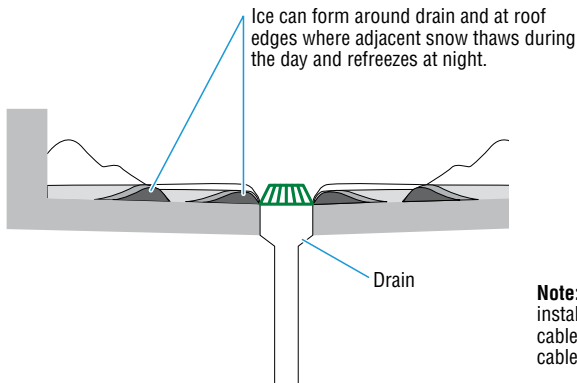

Note: Downspout hanger kits can be installed within drains or UV resistant cable ties can be used to fix the heating cable in-place to the drain dome.

10D Flat Roof Installation

For heating cable finishing instructions refer to page 18

- Finished example of heating cable attached to roof in a flat roof installation method.
- Perform an annual inspection each year of the following:
 - Check visually to ensure no physical damage has occurred to the heating cable.
 - Check and test the ground-fault protection device for proper operation. For GFC model Paladin system refer to the electrical system check section of this guide.
 - Make sure that scuppers, drain domes and downspouts are free from leaves and any other debris.
 - If a control device is installed make sure it operates correctly before each winter season.

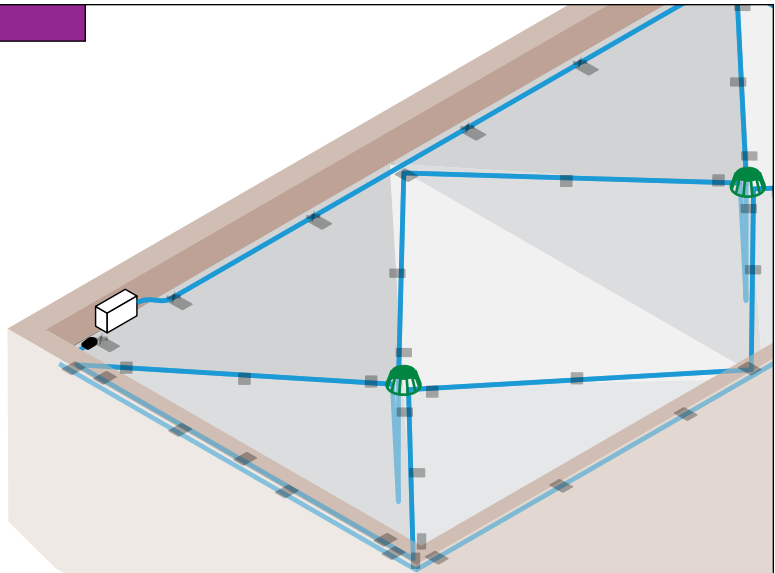

Gutters and Downspouts

Ice may accumulate in the gutters, downspouts and drains. The Paladin heating cable can be used to trace these areas to prevent water back-up.

Gutters:

- One run of heating cable in the gutter is often sufficient. The heating cable should remain against the bottom of the gutter. No attachment in the gutters is normally required but roof clips may be used every 2 feet in the gutter to secure heating cable if needed. Attachment of the heating cable in gutters is generally only required in high flow and strong wind applications and environments.
- For gutters 5-6 inches wide, use two runs of heating cable. For gutters wider than 6 inches contact Heat-Line.
- Paladin is safe for use in metallic and non-metallic gutter systems.
- When using cables ties for installation procedures ensure they are UV resistant.

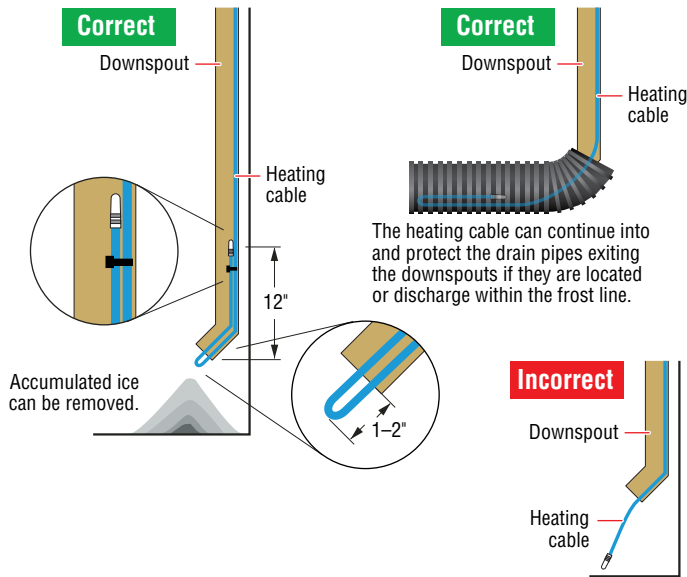

Downspouts:

Run heating cable along gutters and into downspouts as necessary.

- If the downspout is at the end of a run, the heating cable may end at bottom of downspout as shown in illustration below or continue into a drain pipe.
- If downspout is located in the middle of a run, the heating cable must loop back up the downspout to continue along GUTTER. In this case you will need 2 feet of heating per each foot of downspout.
- Downspout hanger brackets should be used to secure and protect heating cable where they enter into the downspout. In applications where the heating cable enters and exits the same downspout 2 downspout hangers will be required. See hanger bracket installation below.
- If the downspouts end underground or continues into a drain pipe underground the Paladin must extend into the drain pipe below the frost line to a warm area.
- In applications where a single run of heating cable is installed in the downspout and the end seal termination ends at the bottom of the downspout, the heating cable end should be backed up the downspout at least 12 inches.

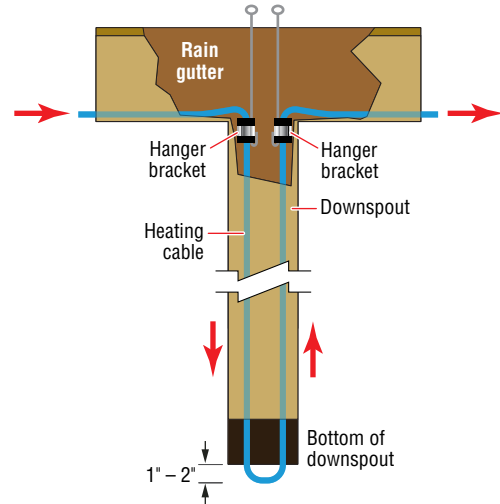

Downspout Hanger Installation:

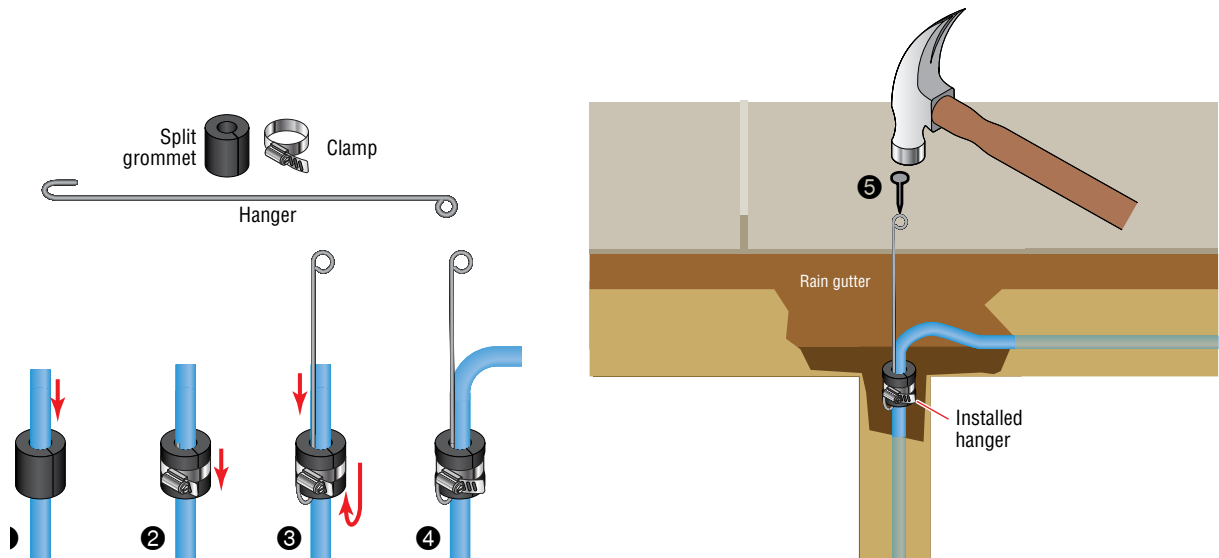

Heating Cable Finishing Instructions

Paladin GFC Models

Power the Paladin heating cable using a suitable receptacle installed in accordance with governing electrical authorities and certified to suit the environment.

Note: The in-line GFCI is certified Rainproof, DO NOT IMMERSE. It is recommended to have the GFCI and power connection within a sheltered area. Example, under an eave overhang.

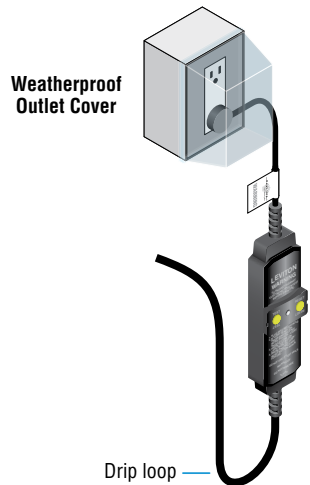

Paladin CS Models

Power the Paladin heating cable using a suitable junction box/ enclosure installed in accordance with governing electrical authorities and certified to suit the environment.

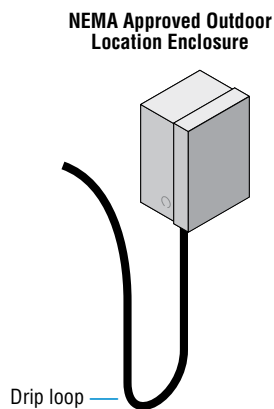

Drip Loops:

Drip loops are important and commonly used at the point of power connection. The non-heated power supply cord-set must have a drip loop before connecting to or entering the power supply. The drip loop allows flowing or falling water to drip free and not run/ track into electrical enclosure. Drip loops must hang lower than power supply.

Extension cords:

Extension cords should not be used. Careful planning of the heating cable layout should be made prior to ordering to make sure lengths are correct and extension cords are not required.

The non-heated power supply cord-set length can be custom ordered to a longer length on both CS and GFC models to avoid the use of extension cords.

Other Considerations:

- Route and secure the heating cable in a manner to avoid possible mechanical damage, such as from ladders.
- Optional controls such as snow sensors, timers, or other approved devices can be used with Paladin.
- Heating cable must be installed in accordance to the National Electrical code or Canadian Electrical Code. The heating cable must be ground fault protected.
- When installing the heating cable and non-heated power cord-set:
 - Do not pull over sharp edges
 - Do not use excessive pulling force
 - Do not kink, crush or stretch the heating cable
 - Do not walk on the heating cable
 - Do not cover the heating cable with any roof materials
 - Do not attempt to shorten or repair a damaged heating cable
- For suitability of heating cable in application not mentioned, contact Heat-Line.
- For Paladin GFC models do not install the power connection in an area where the in-line GFCI could be resting or immersed in water or snow.

Use of Control Devices

Optional controls such as snow sensors, timers, or other approved devices can be used with these systems.

See page 2 under Optional Accessories for common devices. Contact Heat-Line for more information on controls.

Electrical System Connection

Electrical Connection for GFCI (Ground Fault Plug-in) Models

- Unpack the Paladin system plug from its protective package.
- Plug into your dedicated outlet. 120V 5-15R outlet for 120V systems or 240V 6-15R outlet for 240V systems.
- Push reset button on the cord set ground fault device until light comes ON. If light does not illuminate check power to outlet. Do not remove or tamper with the cord set. If used with a thermostat it may be necessary to bypass the thermostat control and plug directly into receptacle to perform test.
- Push test button and light will go OFF. This indicates that the electrical circuit is intact and fully protected.
- Push reset button again and light will come ON. This indicates that your Paladin is working.
- Follow this test procedure before each season and monthly while in use.

Your Paladin system is now fully functional.

If at any time your Paladin system fails to work call your local electrician or Heat-Line for assistance at 1-800-584-4944.

Unplug when not in use.

NOTE: GFCI is NOT water proof and should be well protected from the elements

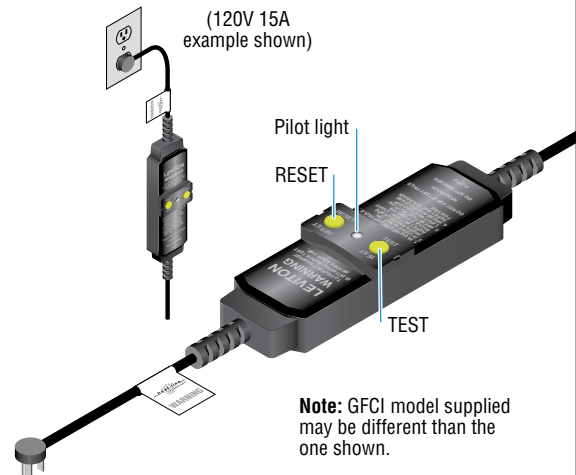

Electrical Connection for CS (Cord-Set) Models into Junction Box

Note: The "CS" version is designed to be installed by a qualified electrician and must be inspected by the governing electrical authority following completion of installation.

- Ensure the Paladin system will be operated on a dedicated ground fault protected circuit with over-current protection appropriate for the circuit conductor size and heating cable length.
- Confirm power is disconnected at the power supply prior to proceeding.
- Remove approved junction box cover.
- Route the Paladin cord-set wires into box with the supplied strain relief fitting.
- Connect appropriate wires together using approved wire nuts. Match wires white to white, black to black, and green to green. In the case of a metal junction box/enclosure, match green to ground screw and confirm screw is tight and secured afterward.

- Double check that the wires have been connected correctly and tight.
- Install junction box cover.
- Establish power to the circuit and test/reset the ground fault device for proper operation.
- Test the GFCI at the breaker before each season and monthly while in use.

Your Paladin system is now fully functional.

If at any time your Paladin system fails to work call your local electrician or Heat-Line for assistance at 1-800-584-4944.

- Heat-Line's MA-10 MilliAMP device may be purchased for ground fault protection. The MA-10 is certified for installation in dry indoor and ordinary locations only.

Non-Metal Junction Box

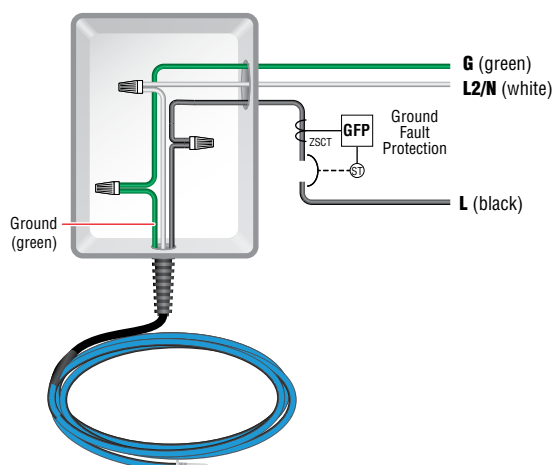

Metal Junction Box

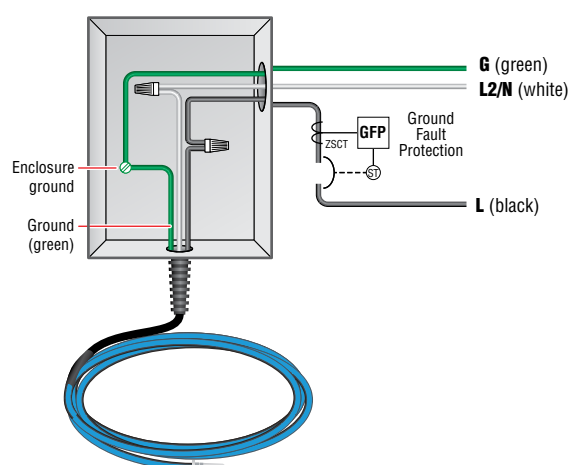

Warnings

- Never bypass the ground fault circuit protection.
- Do not use extension cords with this product.
- Never cut or alter this product in any manner.
- If the ground fault does not reset call an electrician.
- For product or install questions contact Heat-Line.

Limited Warranty

During the time periods and subject to the conditions hereinafter set forth, Heat-Line will repair or replace to the original user any portion of your Paladin Series product which proves defective in materials or workmanship of Heat-Line. Contact Heat-Line or your installer for warranty service.

At all times Heat-Line shall have and possess the sole right and option to determine whether to repair or replace defective equipment, parts or components. **Damage due to natural events or conditions beyond the control of Heat-Line are NOT COVERED BY THIS WARRANTY.**

STANDARD WARRANTY PERIOD: 60 months from date of purchase or 63 months from date of manufacture, whichever ever occurs first.

EXTENDED WARRANTY PERIOD: 120 months from date of purchase or 123 months from date of manufacture, whichever ever occurs first.

ACCESSORIES, COMPONENTS, ELECTRONICS: Not manufactured by Heat-Line, are warranted only to the extent of original manufacturer's warranty.

LABOUR, COSTS, ETC.: Heat-Line shall in **NO EVENT** be responsible or liable for the cost of field labour or other charges incurred by any customer in removing and/or reaffixing any Heat-Line product, part or component thereof.

THIS WARRANTY WILL NOT APPLY:

- (a) to defects or malfunctions resulting from failure to properly install, operate or maintain the unit in accordance with printed instructions provided,
- (b) to failures resulting from abuse, accident or negligence;

- (c) to normal maintenance services and
- (d) to parts not used in accordance with applicable local codes, ordinance and good trade practices;
- (e) if the unit is moved from its original installation location or
- (f) if the unit is used for purposes other than for what it was designed and manufactured,
- (g) to the integral ground fault device and related electronics.

PRODUCT IMPROVEMENTS: Heat-Line reserves the right to change or improve its products or any component thereof without being obligated to provide such a change or improvement for units sold and/or shipped prior to such change or improvement.

WARRANTY EXCLUSIONS: As to any Heat-Line product after the expiration of the time period of the warranty applicable thereto as set forth above. There will be no warranties including any implied warranties of merchantability or fitness for any particular purpose. No warranties or representations at any time made by any representative of Heat-Line, shall vary or expand the provisions hereof.

LIABILITY LIMITATION: In no event shall Heat-Line be liable or responsible for consequential, incidental or special damages resulting from or related in any manner to any Heat-Line product or parts thereof. In the absence of suitable proof of the purchase date, the effective date of this warranty will be based upon the date of manufacture plus 90 days.

Heat-Line Freeze Protection Systems

1095 Green Lake Road
Algonquin Highlands, ON Canada
KOM 1J1
Tel: 1-705-754-4545
1-800-584-4944
Fax: 1-705-754-4567
info@heatline.com
www.heatline.com

Heat-Line, EDGE-CUTTER and Paladin are registered trademarks of Heat-Line Corporation.

Important: All information, including illustrations, is believed to be reliable. Users, however, should independently evaluate the suitability of each product for their particular application. Heat-Line a Division of Christopher MacLean Ltd. makes no warranties as to the accuracy or completeness of the information, and disclaims any liability regarding its use. Heat-Line's only obligations are those in the Heat-Line Standard Terms and Conditions of Sale for this product, and in no case will Heat-Line be liable for any incidental, indirect, or consequential damages arising from the sale, resale, use, or misuse of the product. Specifications are subject to change without notice. In addition, Heat-Line reserves the right to make changes—without notification to Buyer—to processing or materials that do not affect compliance with any applicable specification.



Paladin Series Warranty Form

CONGRATULATIONS!

You have just purchased the most advanced external freeze-protection system available on the market, backed by the finest warranty offered in the industry. Your Paladin Series system comes with a standard 5 year limited warranty with an optional 10 year limited warranty available.

~ The warranty applies only to the original purchaser of the product and is not transferable at any time for any reason. The warranty form must be filled out and returned to Heat-Line within 6 months of invoice date or unit manufactured date plus 9 months to be eligible for the 10 year extended warranty. ~

OWNER MAILING ADDRESS

Name _____
 Address _____

 City _____
 Prov/State _____ Postal/ZIP _____
 Canada
 USA Other: _____
 Home Phone _____
 Email _____

INSTALLATION ADDRESS (if different than mailing)

Name _____
 Address _____

 City _____
 Prov/State _____ Postal/ZIP _____
 Country _____
 Work/Cell _____

PRODUCT INFORMATION

Product Cat.# _____
 Serial # _____
 Length _____

Installation Type:
 External pipe
 Internal pipe
 Tank
 Other: _____

WARRANTY INFORMATION

5 Year Limited Warranty: **INCLUDED!**

10 Year Limited Warranty: \$1.10 / foot (\$33.00 minimum)

PAYMENT DETAILS FOR 10 YEAR LIMITED WARRANTY

System Length*

Units 1 to 240 feet = \$1.10 per foot OR \$33.00 minimum

* For custom lengths involving inches, round up to the nearest foot

System Length*

x \$ 1.10 / ft

= Subtotal

Taxes and Currency

If Canadian Address:
 Subtotal: _____
 Provincial Tax %: _____ Tax Due: _____
Total in CDN Currency:

If U.S. Address or Other Country:
 No Taxes Apply
Total in US Currency:

PAYMENT METHOD

Cheque

Enclose and make out to Heat-Line for full amount

Credit Card:

Mastercard or Visa

Name on Card: _____

Card Number: _____

Expiration Date: ____ ____

LIMITED WARRANTY

During the time periods and subject to the conditions hereinafter set forth. Heat-Line will repair or replace to the original user any portion of your Paladin Series product which proves defective in materials or workmanship of Heat-Line. Contact Heat-Line or your installer for warranty service.

At all times Heat-Line shall have and possess the sole right and option to determine whether to repair or replace defective equipment, parts or components. **Damage due to natural events or conditions beyond the control of Heat-Line are NOT COVERED BY THIS WARRANTY.**

STANDARD WARRANTY PERIOD: 60 months from date of purchase or 63 months from date of manufacture, whichever ever occurs first.

EXTENDED WARRANTY PERIOD: 120 months from date of purchase or 123 months from date of manufacture, whichever ever occurs first.

ACCESSORIES, COMPONENTS, ELECTRONICS: Not manufactured by Heat-Line, are warranted only to the extent of original manufacturer's warranty.

LABOUR, COSTS, ETC.: Heat-Line shall in **NO EVENT** be responsible or liable for the cost of field labour or other charges incurred by any customer in removing and/or reaffixing any Heat-Line product, part or component thereof.

THIS WARRANTY WILL NOT APPLY:

(a) to defects or malfunctions resulting from failure to properly install, operate or maintain the unit in accordance with printed instructions provided,

- (b) to failures resulting from abuse, accident or negligence;
- (c) to normal maintenance services and
- (d) to parts not used in accordance with applicable local codes, ordinance and good trade practices;
- (e) if the unit is moved from its original installation location or
- (f) if the unit is used for purposes other than for what it was designed and manufactured,
- (g) to the integral ground fault device and related electronics.

PRODUCT IMPROVEMENTS: Heat-Line reserves the right to change or improve its products or any component thereof without being obligated to provide such a change or improvement for units sold and/or shipped prior to such change or improvement.

WARRANTY EXCLUSIONS: As to any Heat-Line product after the expiration of the time period of the warranty applicable thereto as set forth above. There will be no warranties including any implied warranties of merchantability or fitness for any particular purpose. No warranties or representations at any time made by any representative of Heat-Line, shall vary or expand the provisions hereof.

LIABILITY LIMITATION: In no event shall Heat-Line be liable or responsible for consequential, incidental or special damages resulting from or related in any manner to any Heat-Line product or parts thereof. In the absence of suitable proof of the purchase date, the effective date of this warranty will be based upon the date of manufacture plus 90 days.

PROOF OF PURCHASE

If a proof of purchase copy is submitted with this warranty application form, the warranty period will be effective as of invoice date. In the absence of suitable proof of purchase, the effective date of this warranty will be based upon the date of unit manufacture plus 3 months.

Proof of purchase (invoice) attached: Yes No

By signing below you acknowledge you have read and understand the full limited warranty document.

Signed: _____

Dated: _____

The warranty form must be filled out and returned to Heat-Line within 6 months of invoice date or unit manufactured date plus 9 months to be eligible for 10 year extended warranty.

Heat-Line is a registered trademark of Heat-Line Corporation.

Heat-Line Freeze Protection Systems

1095 Green Lake Road / Algonquin Highlands, / KOM 1J1 / info@heatline.com / www.heatline.com
ON Canada